

Table of Contents.

0. Abstract.

1. Introduction.

- 1.1. What is Cern ?
- 1.2. The L.H.C. and the ATLAS project.

2. Go to the Inner detector.

- 2.1. ATLAS Inner Detector.
- 2.2. Pixel Detector.
 - 2.2.1. General Description.
 - 2.2.2. The "*omega*" shape stave in Carbon-Carbon from Genoa.

3. Evaporative cooling system for The Pixel detector

- 3.1. Thinking about an evaporative cooling system.
- 3.2. Global view of the final evaporative installation.
- 3.3. Cooling system for tests (small rig)-my contribution.
 - 3.3.1. Description and running of the Small Evaporative Circuit.
 - *Description.*
 - *Gas Handling system and compressor for single-tube.*
 - *Thermodynamic loop of the refrigerant.*
 - *Situation in the laboratory.*
 - 3.3.2. Determination of the Heat Transfer Coefficient (H.T.C.).
 - *How to calculate the HTC for circulate geometry (stave).*
 - *The copper stave structure.*
 - *The Genoa pixel prototype of the pixel structure.*

4. Test results with the small evaporative system.

- 4.1. Experiments with different Inner Diameter tubes (3.6 and 1.5 mm) to determine HTC.
- 4.2. Experiments for Pixel stave prototype.
 - 4.2.1. Temperature profile along the stave.
 - 4.2.2. Heat Transfer Coefficient along the stave.
 - 4.2.2.1. Pixel.
 - 4.2.2.2. Other stave.

First Part, Introduction.

1.1. What is CERN ?

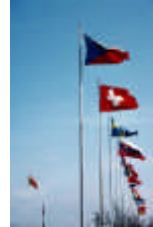

CERN is the European Laboratory for Particle Physics, the world's largest particle physics center. Founded in 1954, the laboratory was one of Europe's first joint ventures, and has become a shining example of international collaboration. From the original 12 signatories of the CERN convention, membership has grown to the present 20 Member States. CERN is on the border between France and Switzerland, just outside Geneva. Its location symbolizes the international spirit of collaboration, which is the reason for the laboratory's success.

It explores what matter is made of, and what forces hold it together. The Laboratory provides state-of-the-art scientific facilities for researchers to use. These are *accelerators*, which accelerate tiny particles to a fraction under the speed of light, and *detectors* to make the particles visible.

Accelerators are huge machines to speed up particles very, very close to the speed of light, and then to let them collide with other particles. The biggest accelerator at CERN, called "**LEP**", measures 27 km around, and is housed in a tunnel about 100 m underground.



[Cern aerial view, and L.E.P.](#)

Detectors are big instruments to observe what happens in these collisions.

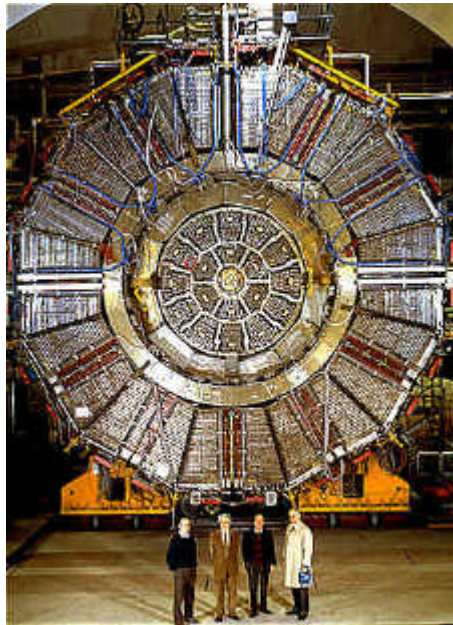

ALEPH detector, one of the four detector of the LEP.

The experiments are like no others in the history of science. Designed and operated by hundreds of scientists, these experiments are often as big as houses. They run around the clock for several months a year, frequently taking years to complete.

1.2. The L.H.C. and the ATLAS project.

- *Go to the future with the L.H.C. (Large Hadron Collider) :*

The new theoretical research needs higher energy to produce particles that physicists expect. So, they decided to build a new accelerator with new detectors able to run at higher energy. And to look for this new physics, the next research instrument in Europe's particle physics armory is the LHC. In keeping with CERN's cost-effective strategy of building on previous investments, it is designed to share the 27-kilometre LEP tunnel, and be fed by existing particle sources and pre-accelerators. A challenging machine, the LHC will use the most advanced superconducting magnet and accelerator technologies ever employed. LHC experiments are, of course, being designed to look for theoretically predicted phenomena. However, they must also be prepared, as far as possible, for surprises. This will require great ingenuity on the part of the physicists and engineers.

Four experiments will be made in the LHC. CMS, ATLAS at the beginning, and then ALICE and LHC-B. As I worked on ATLAS let's have a look at it.

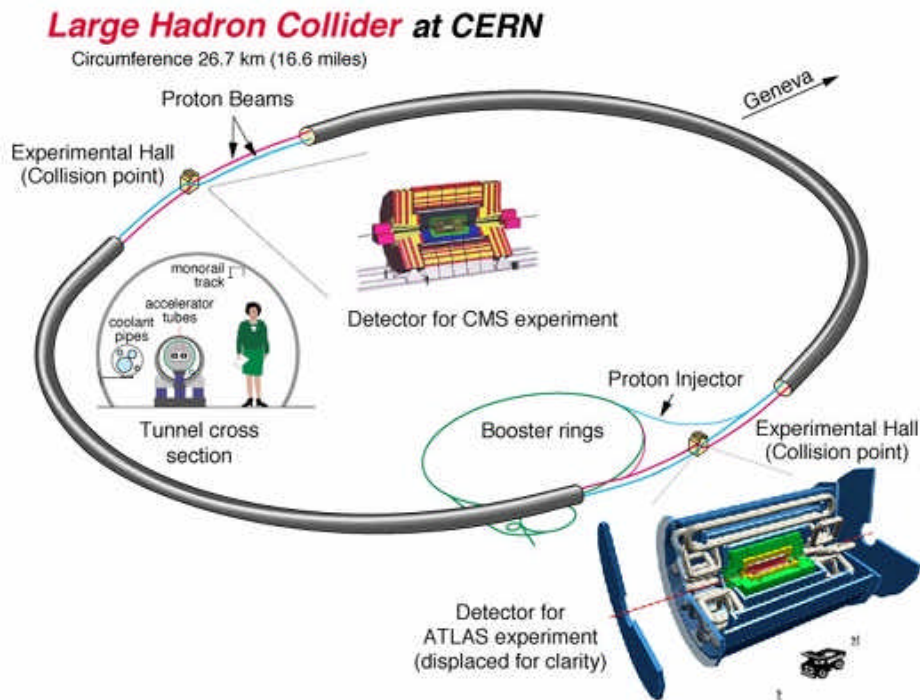

The LHC and its two first experiments.

- *ATLAS, A Toroidal LHC ApparatuS:*

The ATLAS experiment is being constructed by 1700 collaborators in 144 institutes around the world. It will study proton-proton interactions at the LHC at the European Laboratory for Particle Physics CERN.

When protons collide, some events are "interesting" and may tell us about exciting new particles or forces, whereas many others are "ordinary" collisions (often called "background"). The ratio of their relative rates is about 1 interesting event for 10 million background events. One of our key needs is to separate the interesting events from the ordinary ones.

The differentiation between these is based on the observed products of each collision...their identities, energies, directions of motion etc. For example, it may be possible to demonstrate that some observed configurations of outgoing collision products arise from the decay of a new particle. Such observations would then represent the discovery of this new particle. The detector is due to begin operation in the year 2005. A prime physics goal of ATLAS is to understand the nature of mass looking for the Higgs boson, a "generator" of masses of other particles in the Standard model.

ATLAS

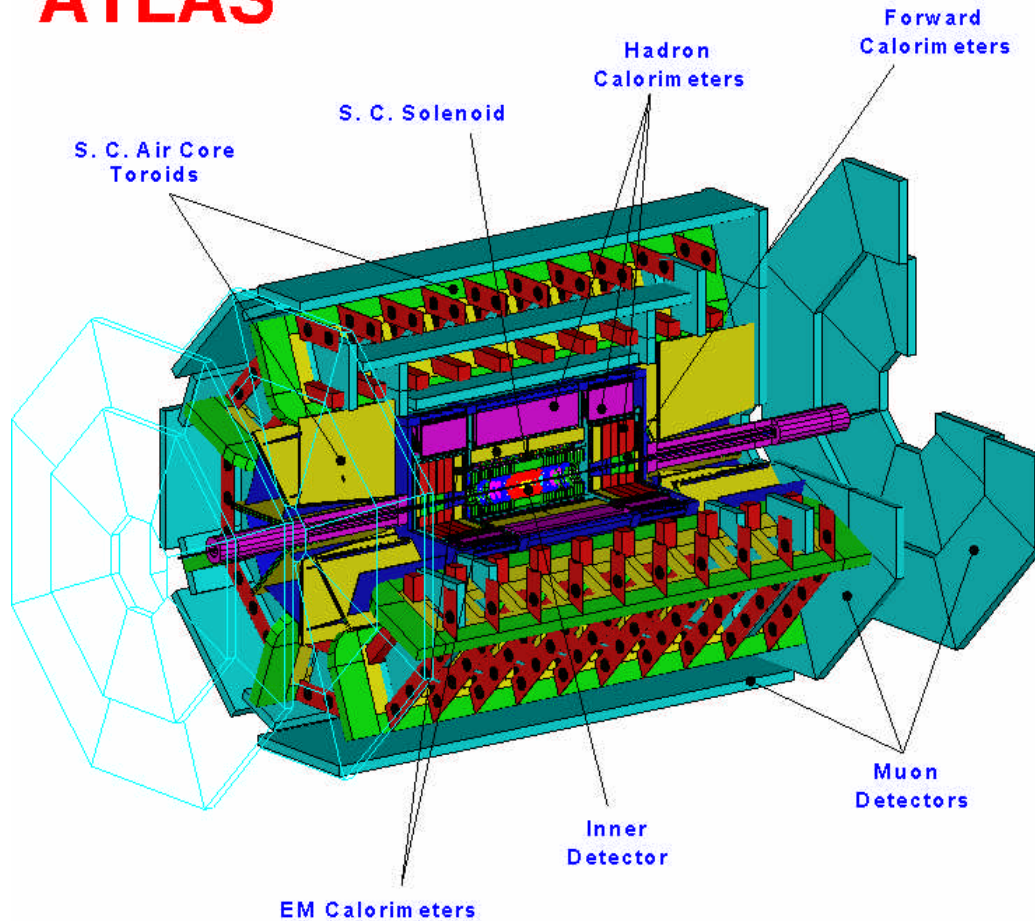

The ATLAS detector and its different detectors.

The ATLAS detector consists of three major components:

- Inner detector - measures the momentum of each charged particle.
- EM Calorimeter - measures the energies carried by the particles.
- Muon Detectors - identifies and measures muons.

The interactions in the ATLAS detectors will create an enormous dataflow. To digest this data we need:

- The trigger system - selecting 100 interesting events per second out of 1000 million others.
- The data acquisition system - channeling the data from the detectors to the storage the computing system - analyzing 1000 Million events recorded per year.

As far as I am concerned, I had just taken part of the Inner detector engineering conception, which is also composed of several parts as we are going to see now.

***Second Part,
Go to the Inner Detector.***

2.1. ATLAS Inner Detector.

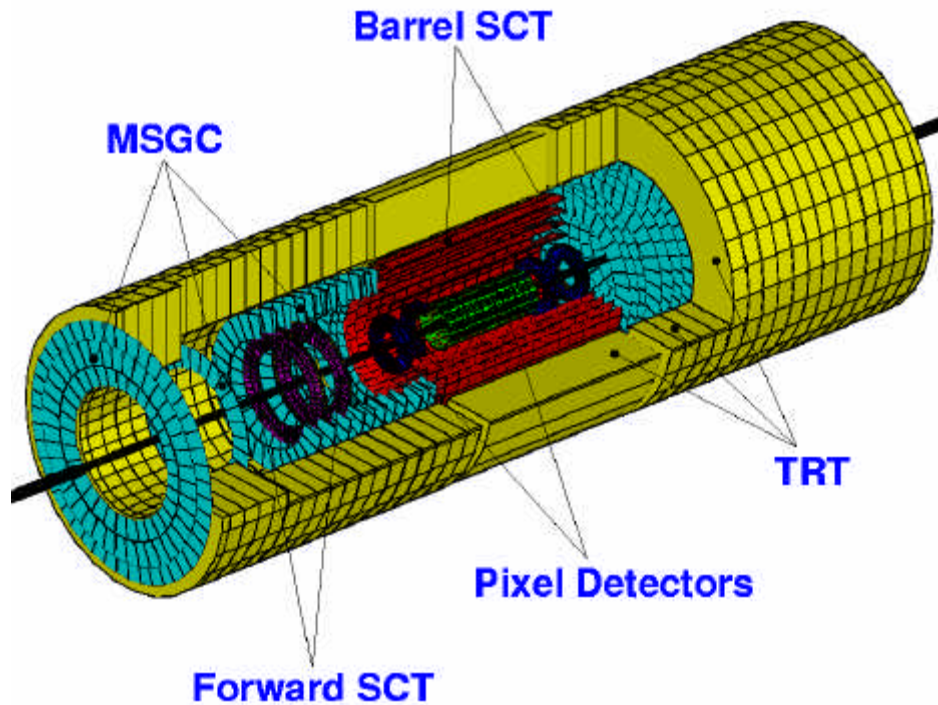

The INNER Detector and its different elements.

This is the closest detector to the beam where the collisions between protons take place. It is composed of three types of detectors, the **SCT** (Semi-Conducting Tracker) in the middle, the **TRT** (Transition Radiation Tracker), and the **Pixel detector** closest to the collision point and beam pipe.

The **SCT** detector will have 4 cylinders around the collision point (barrel) and 9 forward disks at each end. Each cylinder consists of "staves" containing 12 silicon strip detector modules. The **Pixel Detector** has ten forward disks and three cylinders, each containing staves of 13 pixel detector modules.

This paper will be concentrate on the Pixel structure, but some of the tests have been made with other structures in order to understand behaviors and properties of the fluids used.

2.2. Pixel Detector.

2.2.1. General description.

A Pixel sensor is a 16 X 60 mm wafer of silicon with about 80,000 pixels, 50 X 400 microns each. A Pixel module comprises an un-packaged flip-chip assembly of 16 front-end chips bump bonded to a sensor substrate. The front-end chips are a major heat source dissipating more than 14kW into the detector volume. This heat is taken out via cooling channels integrated into the detector support elements.

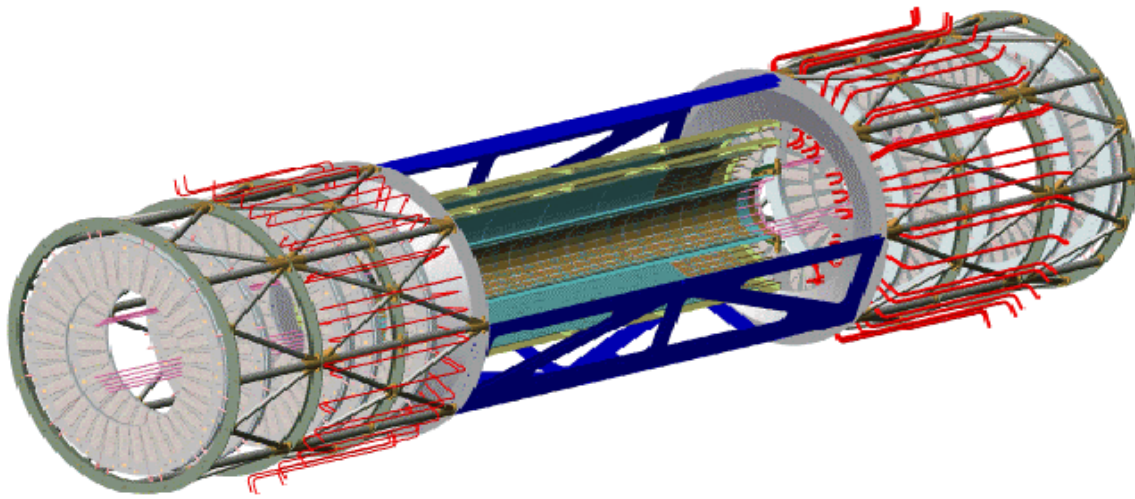

The ATLAS Pixel detector.

The system is composed of modular units. Read-out integrated circuits bonded to silicon detector substrates form the barrel and disk modules. All the barrel modules (1500 approximately) are mounted on identical supporting structures (staves). Similarly all the disk modules (700 approximately) are located on identical support sectors that are joined to form disks.

The Pixel detector system provides critical tracking information for pattern recognition as close as possible to the interaction point to provide the optimal impact parameter resolution.

2.2.2. The "omega" shape stave in Carbon-Carbon from Genoa.

After several studies, it seems that the Genoa stave is the best stave for the cooling system project. Here we can observe the cooling channel for the three layers of the barrel

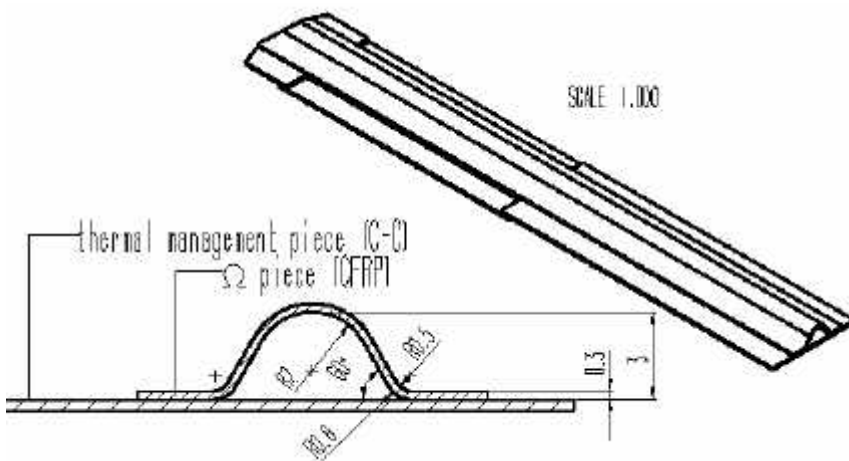

The Genoa Pixel cooling structure.

The omega piece provides the required stiffness with a simple geometry.

The Carbon-Carbon (C-C) structure (**very stiff**) tested gives good thermal properties in all directions: About 1200 W/(m.K) in plane.

About 40 W/(m.K) in transverse. Furthermore, the structure is **light** so we will have a low production of secondary particles.

The main problem is the porosity of the C-C structure because there is a risk of leaks in the cooling system near the beam.

It is impregnated with cyanate-ester epoxy ad the leaks proof.

***Third Part,
Evaporative Cooling System for
The Pixel Detector.***

3.1. Thinking about an evaporative cooling system.

The cooling system for the pixel detectors will have to evacuate a total power of around 14 kW from around 240 pixel detector staves and disk sectors. Pairs of staves or sectors will be supplied with coolant from common tubes, to make around 120 "parallel cooling elements". Heat will be evacuated to the outside world using tubes of low mass and with the smallest practical diameter, to minimize material in the tracker volume.

- *A single phase liquid system ?*

Basically, when we think about a cooling system, the first approach is to try a single phase liquid system: but here, at CERN, many other parameters must be taken into account. Indeed, as it has been already mentioned, the inner detector is really close to the collision point, so the material used must be resistant to the radiation for several years and must produce the minimum background of secondary particles. The aim is to find new particles, so we have to take care of all that will be irradiated. For a liquid system, a bigger tube is needed to evacuate the same amount of heat so the ATLAS community decided to use another technique to cool the pixel detector.

- *Two other candidates, Binary Ice and evaporation.*

Binary ice is a suspension of microscopic ice crystals in a mixture of water with a freezing point depressant. However the physical properties are affected by the temperature, so if the temperature decreases the viscosity of the mixture increases, and that implies larger dimensions for the pipes. Also, safety is a concern; we must pay attention to the conductivity, and the flammability of the coolant in case of a leak. This forced operation below the atmospheric pressure, and the number of constraints rose so high that this technique was not adopted.

So now, the way to test an evaporative system is entirely opened.

Using this technology, heat is evacuated from the pixel detectors via the evaporation of a liquid refrigerant delivered to each stave. At the entry point, the liquid is cooled and atomized in a narrow throttling element (injector or capillary) and impinges as a mist on the inner wall of the cooling channel. Heat is removed from wall due to evaporation of the refrigerant. Vapor is evacuated at the exhaust end of the tube to be recondensed and resupplied in liquid form. Studies of this cooling technique using fluorocarbon refrigerant have been made, and one of the purposes, during my training, has been to test different fluids and understand their behavior.

Interesting liquids that had been already used in particle physics, are saturated fluorocarbons $C_nF_{(2n+2)}$. They have high dielectric strength, satisfy recent environmental protection protocols, and are non-toxic and non-flammable. Furthermore, these fluids have a demonstrated wide range of compatibility, based on many years of exposure, to many common detector construction materials.

Since the cooling base line is now decided, we can review the general installation for the pixel detector.

3.2. Global view of the final evaporative installation.

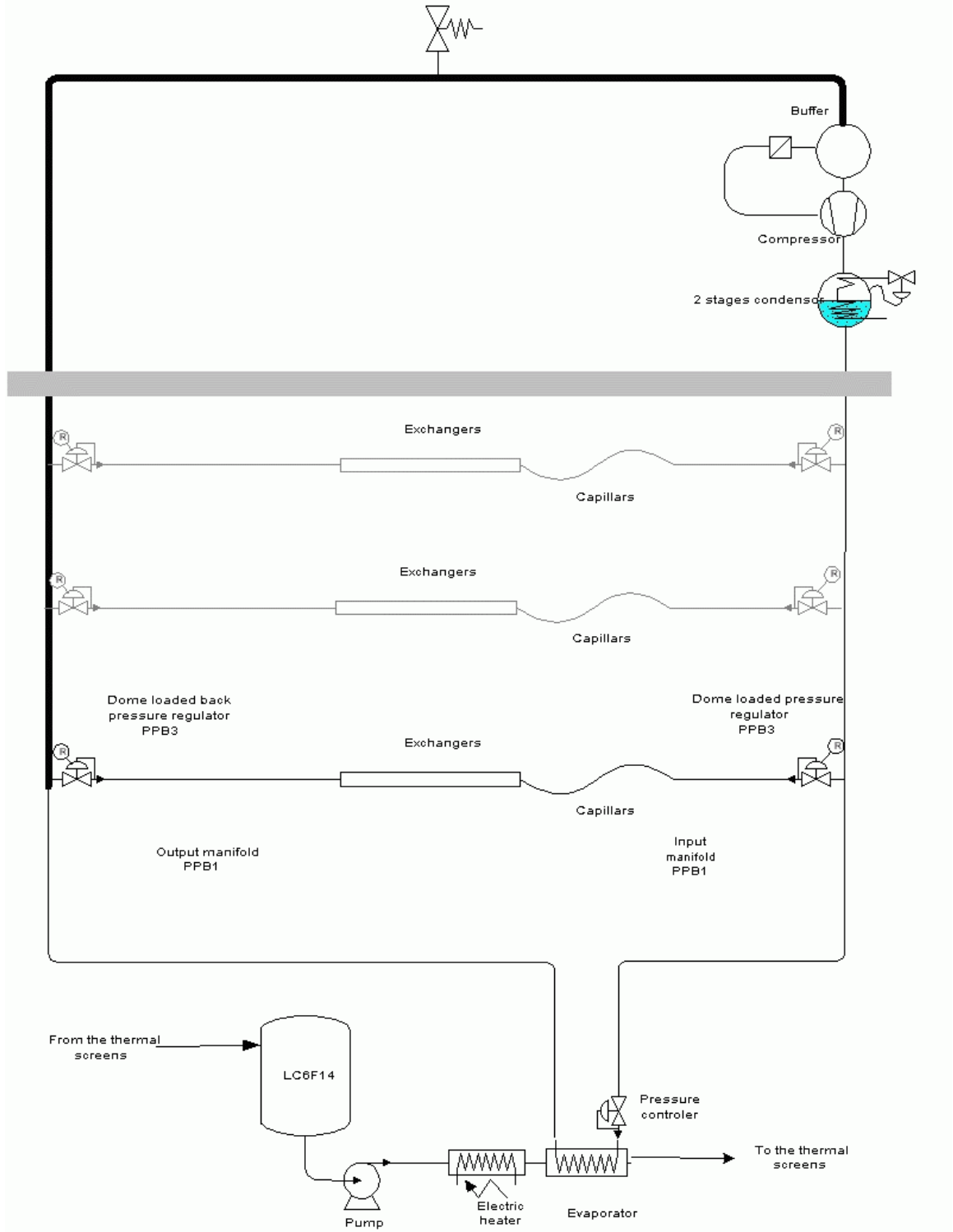

The Global evaporating installation.

This overview shows the complete cooling system, which will be built for the pixel detector and SCT structures, and which will also cool down the liquid refrigerant used to cool down the thermal screens, (i.e. another part of the detector). The system will occupy two caverns. A technical cavern, where there will be the buffer (stock of the refrigerant), the compressor and the condensers and the ATLAS experimental cavern which will contain the detector and its cooling structure. The length of pipe between the two caverns will be about 150m.

Elements in the technical cavern:

- The buffer where the refrigerant will be stored.
- The compressor (scroll compressor presently under test).
- Condenser with subcooling loop.
- The heat exchanger-cooler for the liquid C_6F_{14} circulator used to cool the thermal screen system, where the C_6F_{14} will be cooled down by the same installation. In this manner, we can save the cost of a separate circulator to cool the C_6F_{14} for the thermal screens.

Elements in the detector:

- Parallel evaporative circuits composed of a pressure regulation valve, a capillary as throttling element, the evaporative structures (staves and wheels) to cool the detector, and a back pressure regulation valve.

3.3. Cooling system for tests (small rig) - My contribution.

3.3.1. Description and running of the Small Evaporative Circuit.

- Description:

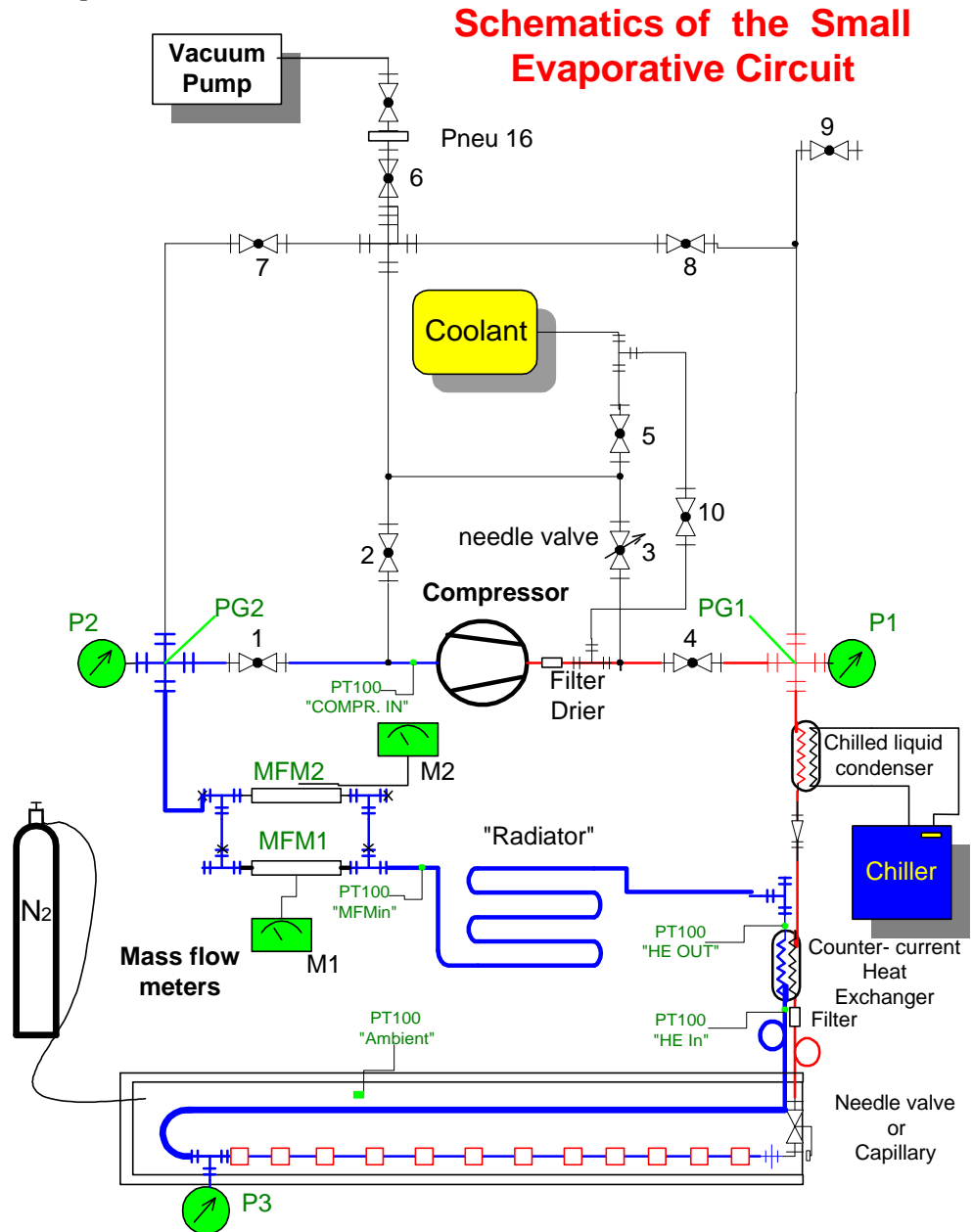

This is the technical drawing of the evaporative recirculator that I used for measurements, so at the beginning of my training I had to learn and understand the circuit. Some valves are used to control the mass of circulating fluid in the circuit when it is running; others are there to regulate the boiling pressure in the pipes of the system.

Basic instrumentation:

Three pressure gauges are placed in the circuit (before and after the compressor, and at the end of the stove under test), two flow meters are placed in parallel in the vapor return line. The four temperature sensors (before and after the heat exchanger, before the flow meter, and before the compressor) give us a global idea of circulation dynamics.

Individual procedures for handling system and compressor for single-tube and heat transfer coefficient measurement:

1. Evacuate the circuit: *only if you want to charge or change the refrigerant in the circuit.*

1. Make sure that valves of the vessel with refrigerant are closed.
2. Connect a vacuum pump to valve No. 6 (be careful with connection).
3. Close valves No. 7, 8, 9 and open valves No. 1, 2, 3, 4, 5, 10.
4. Turn the vacuum pump on and slowly open valve No. 6.
5. Wait at least 15 minutes to finish the evacuating (when you hurry), in other case wait for a night to finish the evacuating.
6. Close the vacuum pump and observe pressure change of (when it is fast, there is possible leak the circuit), pressure grows up to 10 mbar.
7. If everything seems to be OK you can close the insulating box.
8. Close valve No. 6, disconnecting the vacuum pump.
9. Close all the valves.

2. Chiller start up:

1. Turn on chiller to II level.
2. Open the red valve for tape water supply into the chiller.
3. Push set.
4. Set desired temperature of the chilled liquid.
5. Push set to confirm temperature.
6. That's all.

Note: When something doesn't work, than restart system and repeat all steps above.

3. Charging the recirculator with refrigerant (from vacuum):

1. Open N₂ line.

To start the compressor, make sure that there is 1 bar difference in pressure [Pin; Pout], and that the input pressure to the compressor is not too high (more than 1 bar absolute). In this case go to N 4) and come back here.

2. Check the valves No. 5 and 6, they should be closed.
3. Open valves No. 1, 2, 3, and 4.
4. Open valves on refrigerant buffer; the blue valve (manometer) and the red valve (gas valve).

5. Slowly open valve No. 5 – fill system up to 1 bar absolute (“0” on manometer) and then close valve No. 5.
6. Close valve No. 4.
7. Turn on compressor – green button.
8. Very slowly open valve No. 4.
9. Close valve No. 3.

4. When starting and differences between P1 and P2 is higher than 1 bar (compressor doesn't work):

1. Close valve No. 1, 4.
2. Open bypass- valves No. 2,3.
3. Slowly open valve No. 6 so that pressure in the circuit is lowered and quickly close (be aware of the fact that you are losing some refrigerant) and try to turn compressor on.

5. Adding mass:

1. Slowly open valve No. 5 – P1 grows up ~ 3 bar absolute (maximum for compressor is 7 bar absolute – 6 bar on the manometer).
2. Observe total flow on flowmeters (you see for example 0.15 g/s).
3. Wait for about 10 minutes, when mass flow is lower or the same as before, repeat previous step; when mass flow is higher than before, wait for 2-3 hours for stable running conditions of the circuit.

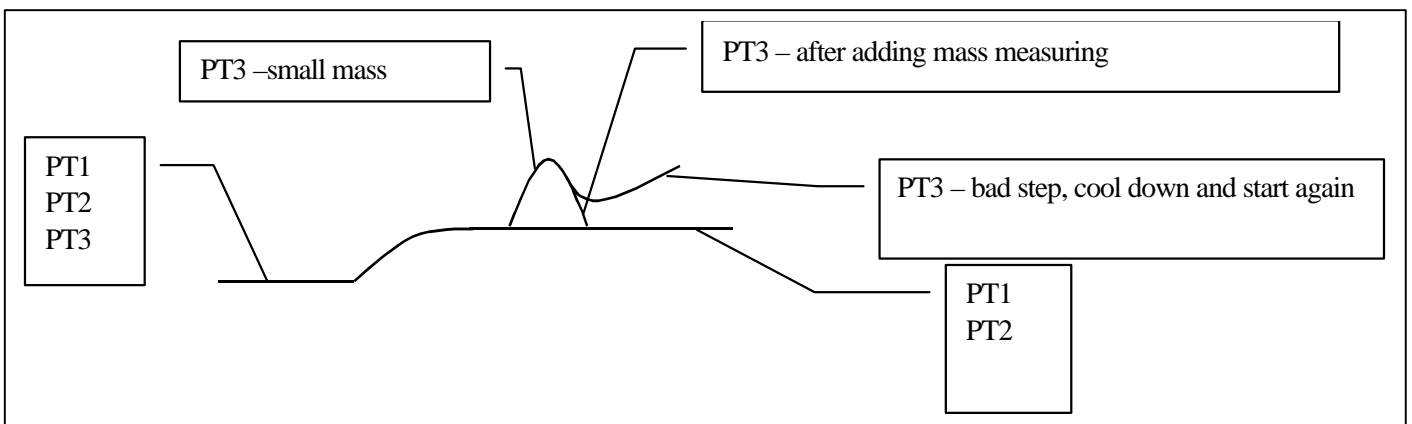

Fig#: Typical Temperature behavior as small circulator came into thermal equilibrium.

6. Closing the circuit:

1. When $P1 >$ pressure of the refrigerant reservoir – open valve No. 10 up to $P1 =$ coolant's tank pressure.
2. Close valves No. 5, 10, the valve on the reservoir.
3. To sent coolant and $P1 <$ pressure on vessel with refrigerant, slowly open valve No. 9 and quickly close and repeat this, NEVER OPEN valve No. 6 – that sucks air to the circuit.
4. Switch off compressor.

7. Decreasing mass:

- To put coolant back into reservoir, and $P_1 < \text{coolant's tank pressure}$, slowly open valve No. 9 and quickly close and repeat this, never open valve No. 6 – that sucks air to the circuit.

- Fundamental schematics of the cooling loop for ATLAS:

Simple Schematics of the ATLAS Inner Detector Cooling System

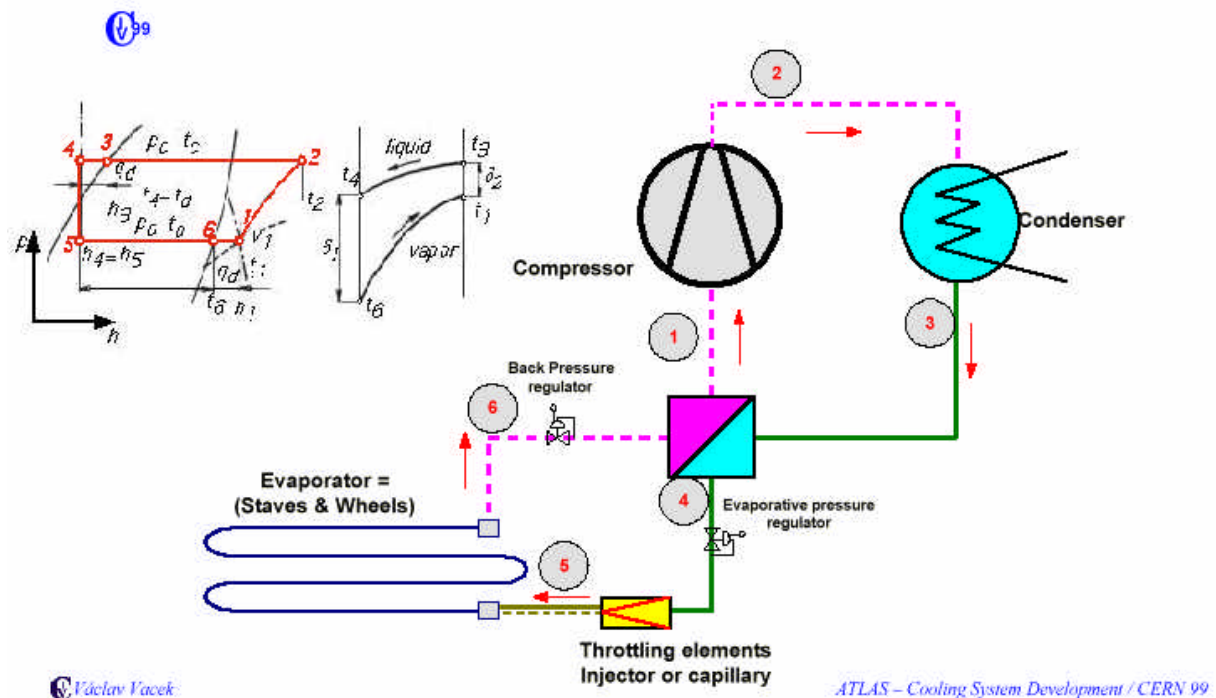

With those schematics of the evaporative cooling loop, we are going to follow one loop of the refrigerant, and we can also observe the loop in the P-h (Pressure-enthalpy) and T-s (temperature-entropy) diagram.

- First (1), the refrigerant in vapor phase passes through the compressor, its enthalpy increases.
- Then, the superheated vapor (2) form is condensed in order to achieve the liquid form required for the evaporation in the stave.
- We are now in point (3) and the liquid passes in the sub-cooling heat exchanger to decrease its temperature. (We are going to explain it later).
- The liquid refrigerant at high pressure enters into the throttling element (injector or capillary) where its pressure is reduced at constant enthalpy ($h_4 = h_5$). The refrigerant is ready to enter the evaporator (the stave), point (5).
- After being evaporated, the vapor, at low temperature (look at t_6) passes in the subcooling heat exchanger, and it returns back into the compressor.

What is going on in the sub-cooling heat exchanger?

If we look at the P-h diagram, (3) represents liquid form refrigerant and if this liquid would go directly in the throttling element (where the pressure decreases as between points (4) and (5)), we would end up throttling at higher enthalpy than in point (5). The enthalpy difference between (5) and (6) (where the evaporation is made) gives us the amount of heat that will be taken away by the refrigerant. So the higher this difference is, the higher the power extracted will be.

We can note that in the sub-cooling heat exchanger the temperature of the liquid (3) decreases due to the lower temperature of the vapor going out of the evaporator (6) and the saturated vapor is superheated (6 to 1). (See the P-h diagram).

- *Situation in the laboratory:*

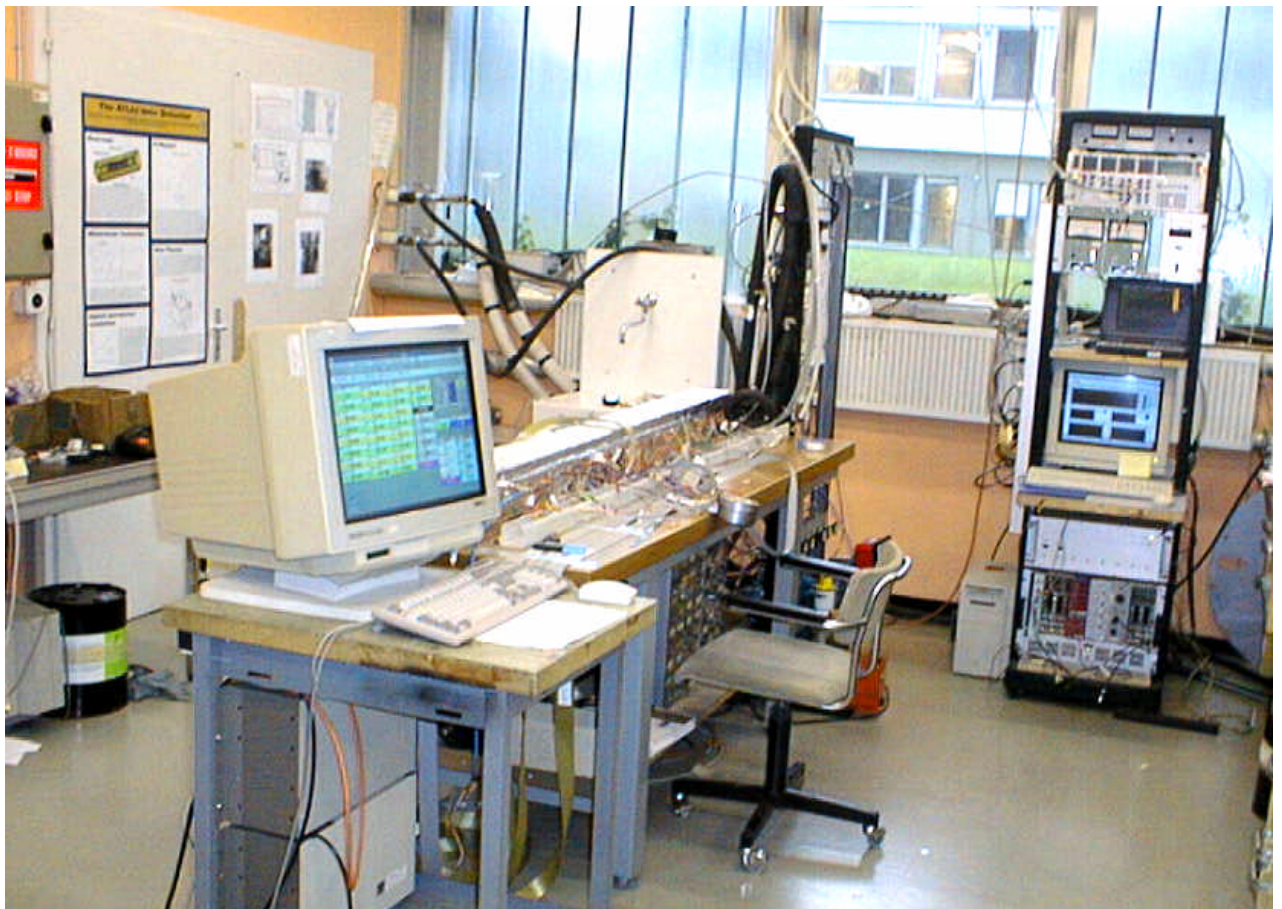

[Small evaporative circuit with the Prague DAQ system & Insulated](#)

The basic instrumentation is connected to the Data Acquisition System (DAQ) developed at the CTU Prague and the staves (the copper stave or the pixel) used for the test, which are instrumented with heaters (to simulate the heat dissipated by the detector) and also with temperature sensors. All these sensors are also connected to the DAQ system.

Prague Mobile DAQ System Layout

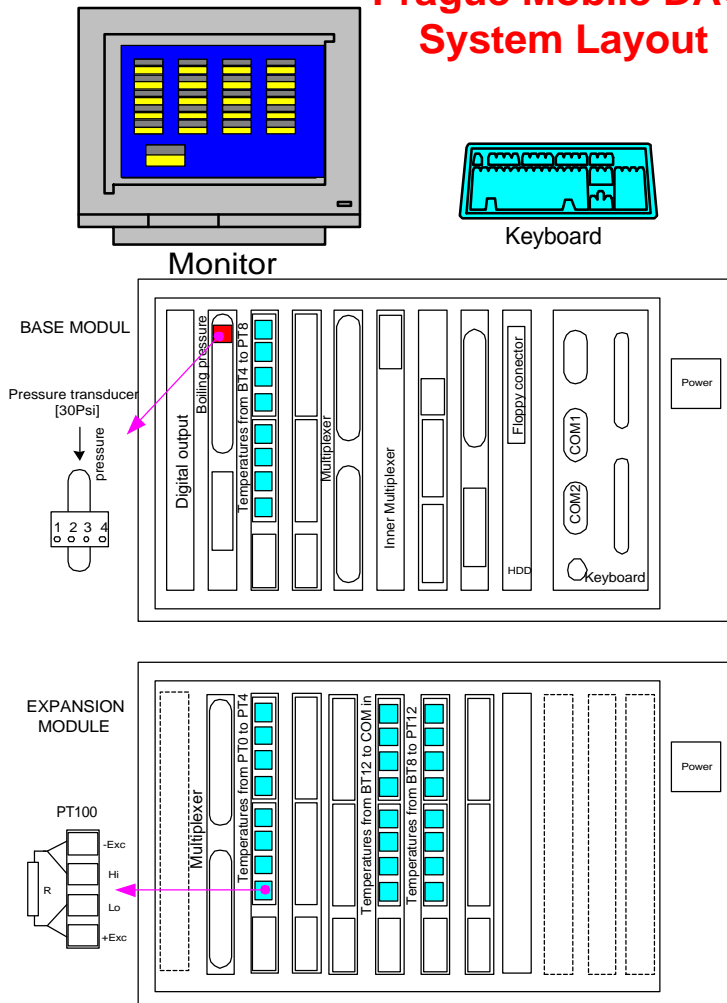

This DAQ enables us to visualize all the temperatures we need to understand the behavior of our evaporative circuit and, so we can reach the correct, and stable conditions required for our measurements also to calculate the Heat Transfer Coefficient (HTC). Since the HTC evaluation depends also on the individual structure under the test, we usually needed proper instrumentation for each structure.

3.3.2. Determination of the Heat Transfer Coefficient (HTC).

The HTC of a fluid reflects its capacity to remove an amount of heat from the wall of a tube. For an evaporative cooling system, we are looking for a fluid with a high HTC and also fluid satisfying other design parameters (Inner-Diameter of the stave, heat exchange surface, allowed pressure for the stave for example).

- How to calculate the HTC for circulate geometry (stave):

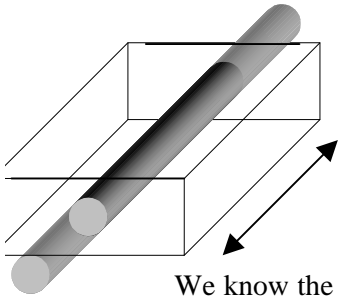

$$a = \frac{Q}{\rho \cdot D \cdot L \cdot \Delta T}$$

Q Heat [J/s].

a HTC [W/m².K].

$\pi \cdot D \cdot L$ Contact Area [m²].

D Inner Diameter of the tube [m].

L Length of the contact area [m].

We know the *Area* (geometrical characteristic of the stave), and the *Heat flux* (Q) is given by the heater element. We can measure the temperature difference (ΔT) and calculate HTC from this.

- The copper stave structure:

This structure is composed of 12 *copper blocks* along the 1.6m stave, whose temperatures are read by the DAQ (BT1 for example). Before each copper block we measure the temperature of the tube (e.g. PT1 for block number one).

Position of the sensors attached to the single-tube for heat transfer coefficient measurements

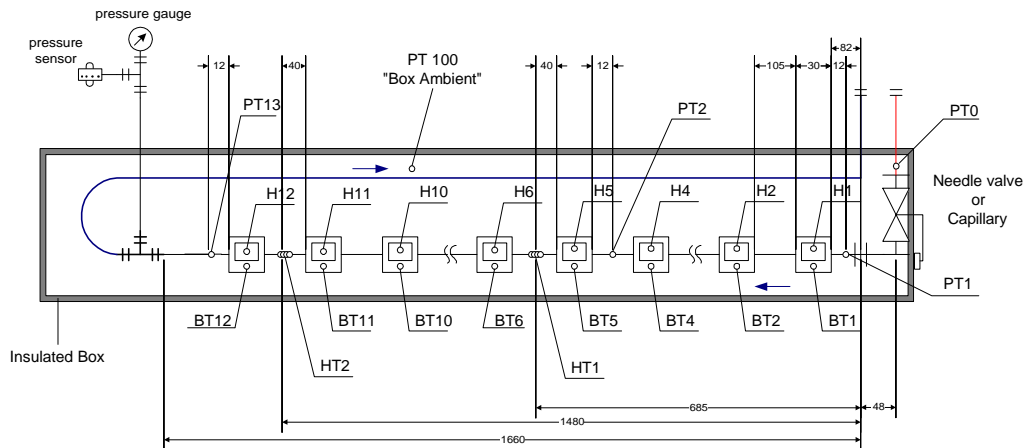

HT (1,2) - coil heater-thermometers

PT (0..3) - PT100 sensors on the pipe [total number of sensors on the pipe = 13]

H (1..12) - heaters -on blocks

BT (1..12) - PT100 sensor on the blocks [total number of sensors on the blocks = 12]

So, for each block we know the temperature of the copper block and the temperature of the tube which is considered equal to the temperature of the fluid, so $PT1 = T_{f1}$. We also assume that $BT1 = T_{w1}$ is the temperature of the tube wall in the copper block. So we can determine the temperature difference that we need for HTC evaluation, $\Delta T = T_w - T_f = BT - PT$.

$$\Delta T = BT - PT$$

Data were recorded each 10s, so we had to analyze the recorded data in order to find stable conditions and make averages of each value, PT1, BT1, PT2, BT2... We could then calculate the HTC over the length of the stave.

• Measurements with the Genoa prototype pixel stave structure:

I have already talked about the Genoa structure, as far as concerned its properties, but now I am going to describe how we evaluated HTC for this stave.

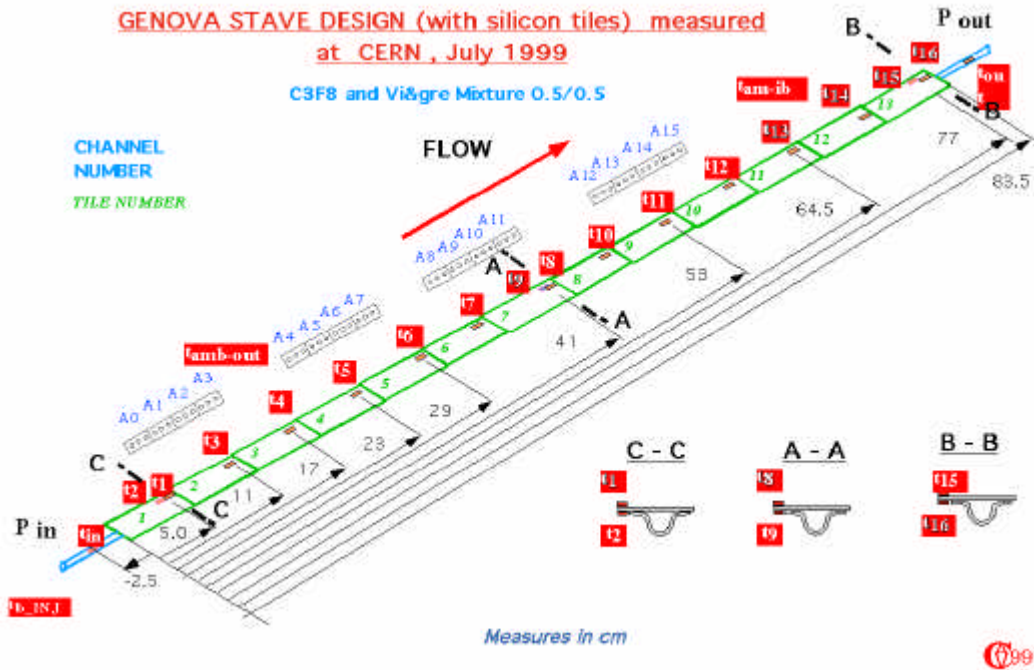

The formula is always the same, but the parameters and the temperature gradient are different. We know the *Area* (it is the linear part of the omega cross section of the stave multiplied by the tube width at the bottom of the "omega" channel), and the heat (*Q*) is given by the heating elements.

To determine ΔT , we need T_w and T_f , $\Delta T = T_w - T_f$.

First we measure T_{in} and T_{out} of the fluid in the stave. We assume that due to the pressure drop along the stave, the temperature profile in the stave is linear with the length. So we know the temperature of the fluid T_f all along the stave.

Since we measure the temperature on the top of the Carbon-Carbon structure, $T_{wmeasured}$. we have to transpose it to the wall inside the tube. Based on theoretical and experimental studies made at Genoa we know that the difference between the top of the structure and inside the surface of the stave is 3.1° or 2.9° (depending of the position along the stave). So we can estimate the temperature of the wall (inside the Ω cooling channel) $T_w = T_{wmeasured} - (3.1 \text{ or } 2.9)$.

$$\Delta T = (T_{wmeasured} - \{3.1\}) - T_f$$

$$\Delta T = (T_{wmeasured} - \{2.9\}) - T_f$$

After making averages out of the recorded data, we can get the results values of the HTC.

***Fourth Part,
Test results with the Small
Evaporative System.***

4.1. First experiments with the copper staves (3.6mm and 1.5mm Inner Diameter) for HTC measurement and temperature profile.

In this part I am going to present the significant results I obtained with the small evaporative system. Indeed, we recorded plenty of data but it I have tried to take the most interesting and important things we observed for the development of the Pixel project.

4.1.1. The 3.6mm Inner Diameter tube.

My first work had been to make measurement with a copper stove of 3.6 Inner Diameter tube in order to train myself with the system. Indeed, these Heat Transfer Coefficient measurement had already been made by Mr. Vacek and Mr. Hallewell. So I could compare my results with theirs, and we obtain the values.

First, we inject some coolant in the circuit and we wait an hour or an hour and a half the temperature profile to stabilize. Once the system is stable we can heat it, for the copper stove (3.6mm or 1.5mm Inner Diameter tube) we will speak of the heat per block. That is to say that, as there are 12 heater blocks we have the following correspondence:

- 2W/block → 24W for the tube.
- 4W/block → 48W for the tube.
- 6W/block → 52W for the tube.
- 8W/block → 96W for the tube.
- 10W/block → 120W for the tube.

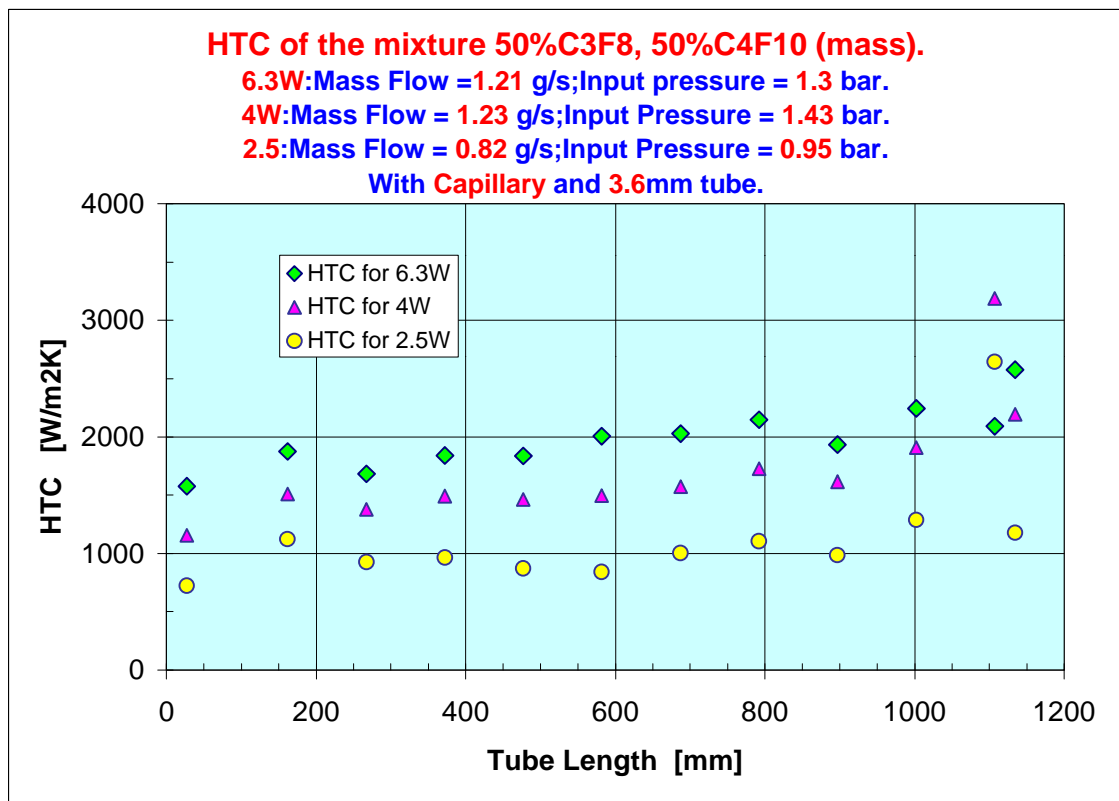

We can observe that the Heat Transfer Coefficients are higher when the power increases, but the important thing we have to note is that the values are between 1000 and 2000 $\text{W/m}^2\cdot\text{K}^{-1}$ for a mixture of 50% C3F8 and 50% C4F10 (mass).

It is also important to say that the HTC is stable over most of the length of the tube, indeed the behavior of the refrigerant inside the tube can influence the stability of the HTC.

We can have the evolution of the HTC with the vapor fraction in the pipe. In fact, as the refrigerant moves forward in the tube the vapor fraction increases so there is a correspondence between the length of the tube and the vapor fraction.

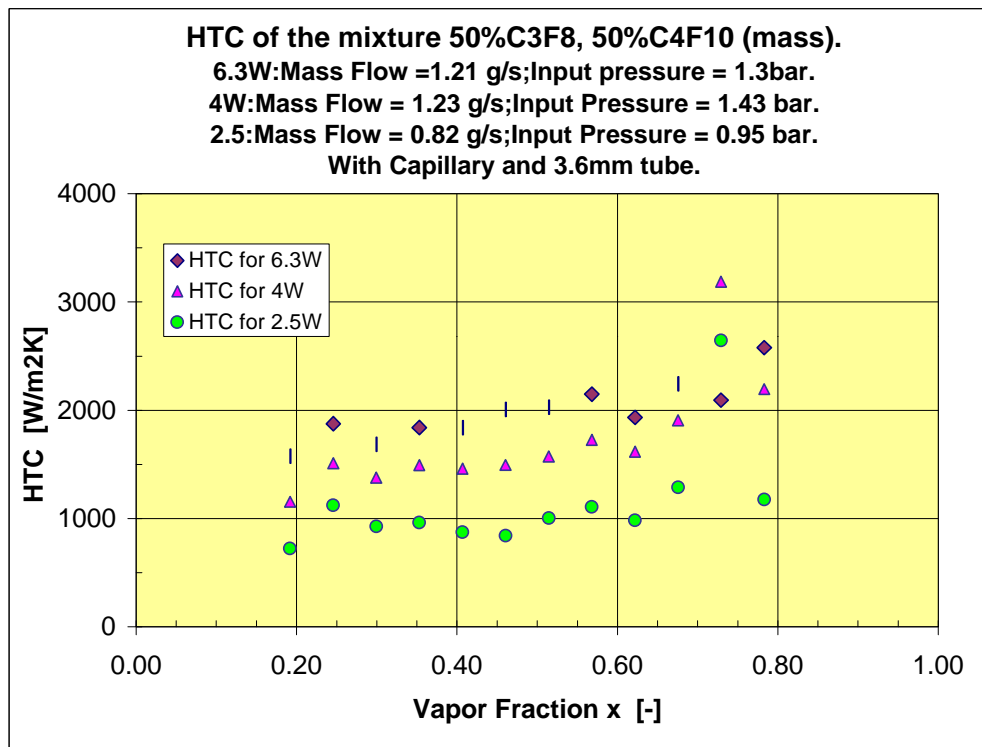

At the entry of the tube the vapor fraction is about 20%, it means that we do not have all the capacity of the liquid refrigerant to catch the maximum power it can. At the end of the tube there is 80% of vapor, so there is some liquid refrigerant which do not evaporated during the process. But this liquid can evaporate later in the exhaust tube.

However the results were in good agreement with these previously obtained.

After this first series of measurements and calculateions we used another copper tube, with a smaller Inner Diameter (1.5mm), because theory suggested that the heat transfer increases when the diameter of the tube is reduced. This is due to a less power lost by conductivity (in the metallic part) even if the contact area is reduced. So we tested this 1.5mm Inner Diameter copper stave.

4.1.2. The 1.5mm ID stove.

This time we did not use all the temperature sensors, because when we have re-instrumented the new tube we lost some temperature sensors and decided that we could see the behavior even if we only had three points of temperature measurement (block and fluid for each point). I am going to present two runs, with C_3F_8 as refrigerant, the first for 2.5W/block and the second for 5W/block. For each, the temperature profile along the tube and the associated Heat Transfer Coefficient are shown.

- *2.5W/block:*

The Temperature of the fluid found from measurement of the temperature of the tube just before a block. A sensor gives us the temperature of the block.

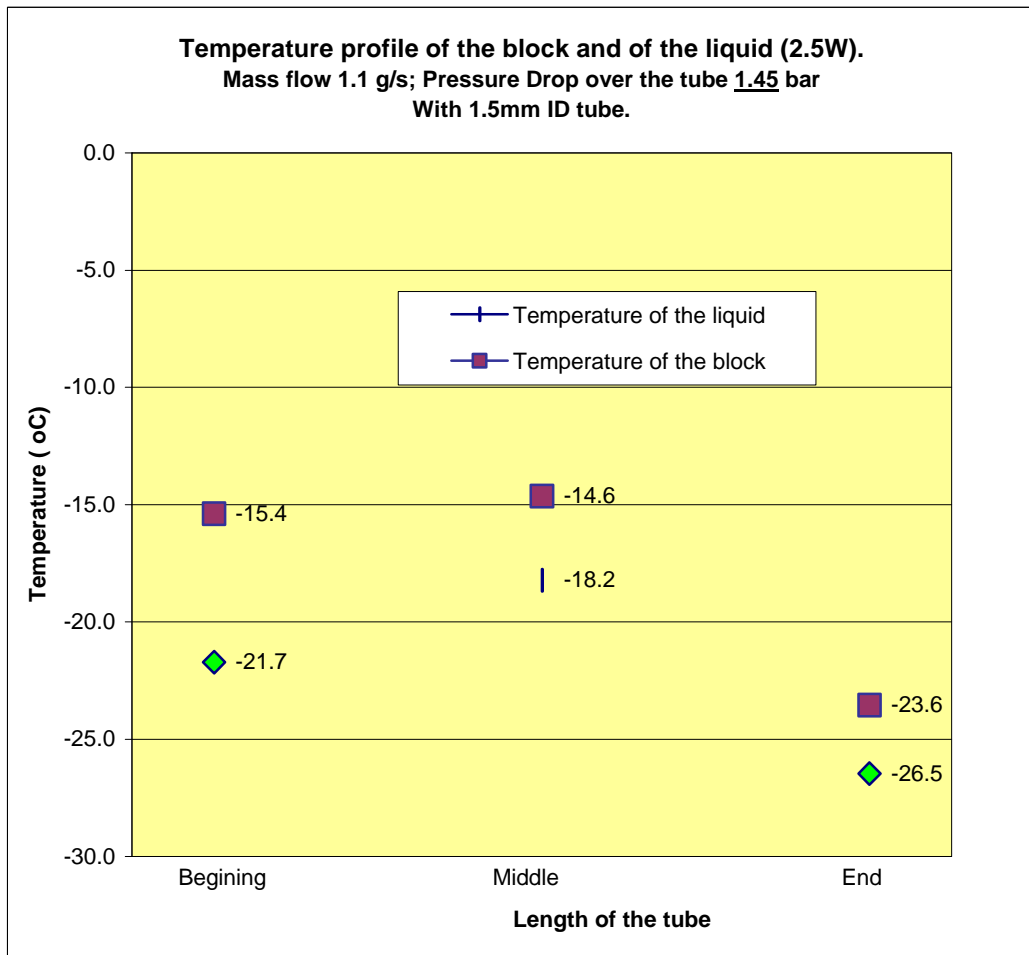

The temperature of the block is always higher than in the tube (the block is heated to 2.5W).

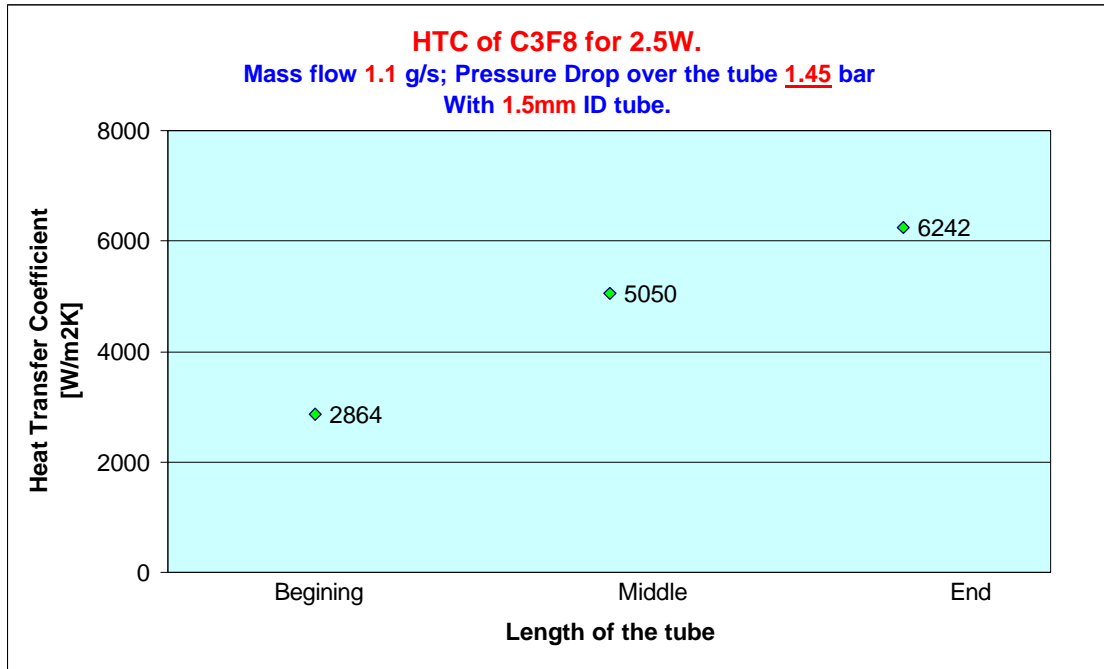

It is clear that the Heat Transfer Coefficients are higher than for the 3.6mm Inner Diameter tube. But, it is not the same refrigerant and what is interesting with this tube, is that:

- The HTC are not stable along the tube.
- The pressure drop over the length of the tube is higher and unacceptable for the structure.

In fact, it seems that the tube behaves as a capillary, and that the evaporation of the refrigerant is difficult. There is probably not enough space inside the tube for a good evaporation of the fluid, furthermore the higher pressure drop may also mean that we are just at the limit of a capillary behavior.

So these tests could mean that despite the improvement (in HTC) given by a smaller Inner Diameter tube, this is not the way to follow.

- 5W/block:

For 5W we get the same kind of result with high Heat Transfer Coefficient but also the same problem to keep the pressure drop low. Indeed, this time the pressure drop is out of the gauge range, so it is more than 1.5 bar. It is not reasonable to make more experiments with this smaller tube. And at this moment of my training we received the pixel structure form Genoa, and it was the moment to test it at CERN.

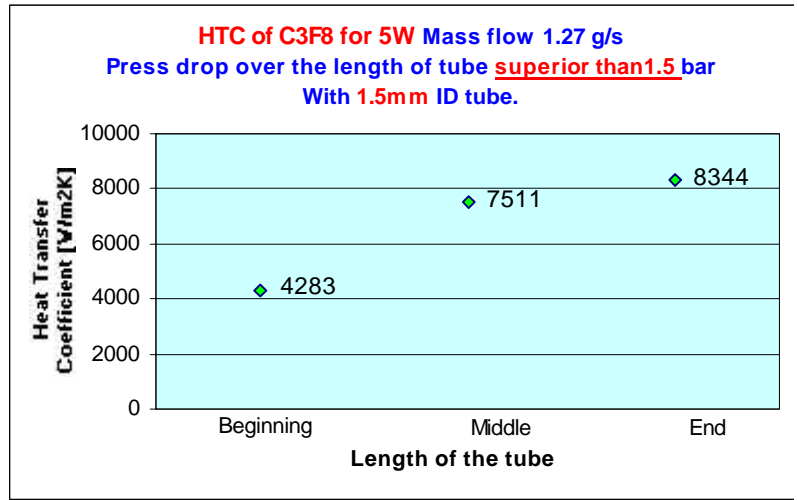
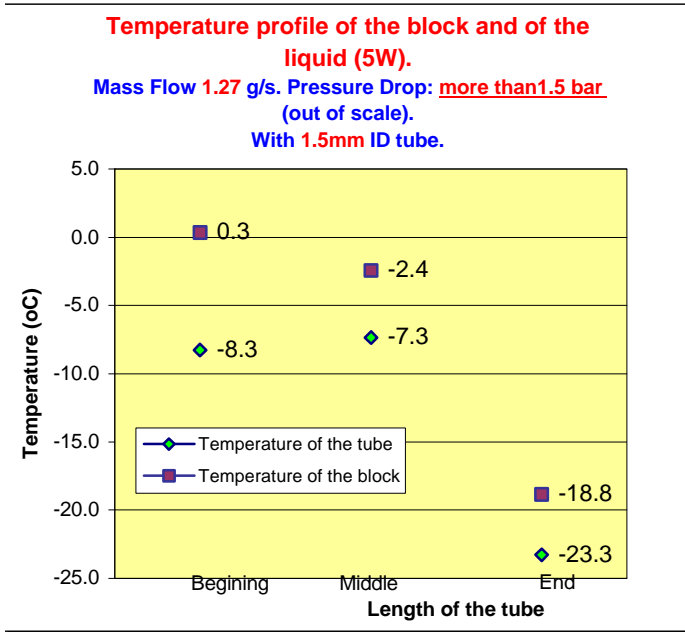

4.2. Experiments with the Genoa pixel prototype.

4.2.1. Temperature Profile along the stave.

As it is explained in the third part (), the calculate of the Heat Transfer Coefficient is different for the Genoa pixel prototype than for the copper stave, so I am going to present some results about the temperature profile of the refrigerant (mixture of 50% C_3F_8 , 50% C_4F_{10} and C_3F_8 pure) and of the structure.

We have a representation of the temperature for 55W with the mixture (the maximum we could reach) and for 100W with C_3F_8 pure.

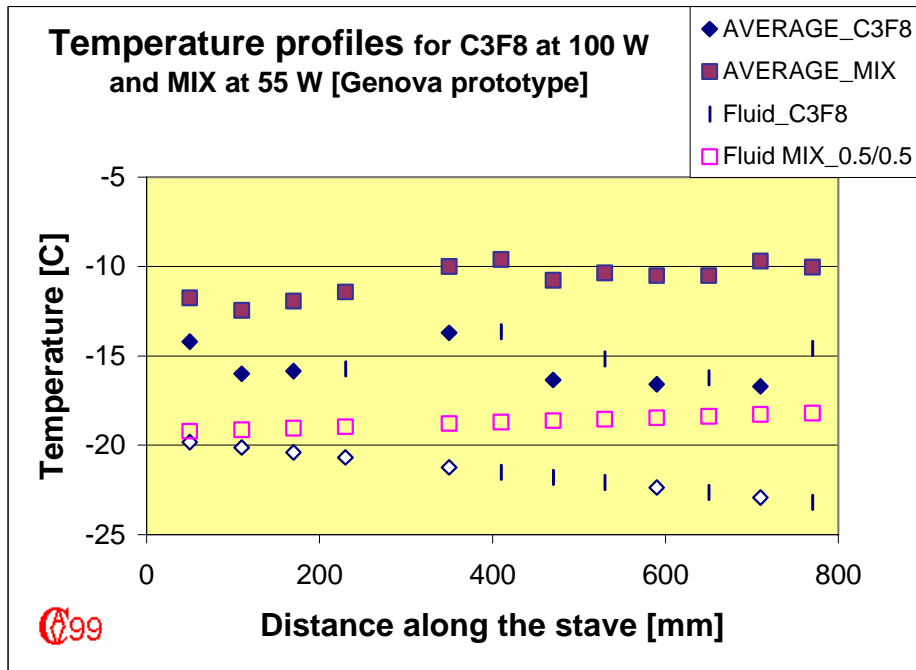

The first thing we can say, is that the temperature of the refrigerant does not follow the same law. One is pure and its temperature is linear with the pressure drop so the temperature goes down in a linear way along the tube. And for the mixture it is different because there is not so simple law than for a pure fluid.

We can add that, even for a higher power (100W) than for the mixture (55W), the temperature of the structure is lower with C₃F₈ as refrigerant. And we were not able to cool down the stave at 100W with the mixture.

4.2.2. Heat Transfer Coefficient over the stave.

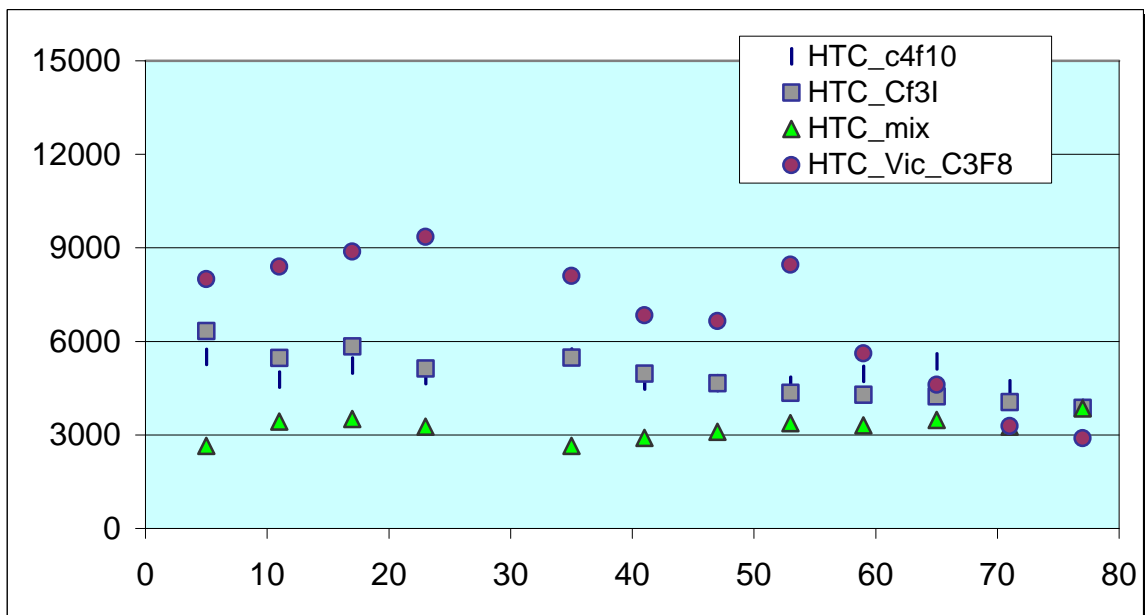

The measurement of these Heat Transfer Coefficients show that the mixture which first purpose was to combine the properties of the two fluids, C_3F_8 which has a good HTC but a high boiling pressure, and C_4F_{10} which has a most interesting boiling pressure but a lower HTC. And the measurement show that using a mixture is the worse situation for the HTC, that may due to the most complicated process of mixture-evaporation. Indeed, the composition of the mixture does not stay the same while the evaporation is going on. One evaporates before the other, and there is no model for this kind of evaporation.

4.3. Back to the 3.6mm ID copper stave.

4.3.1. HTC measurement for the mixture (80% C_3F_8 ;20% C_4F_{10}).

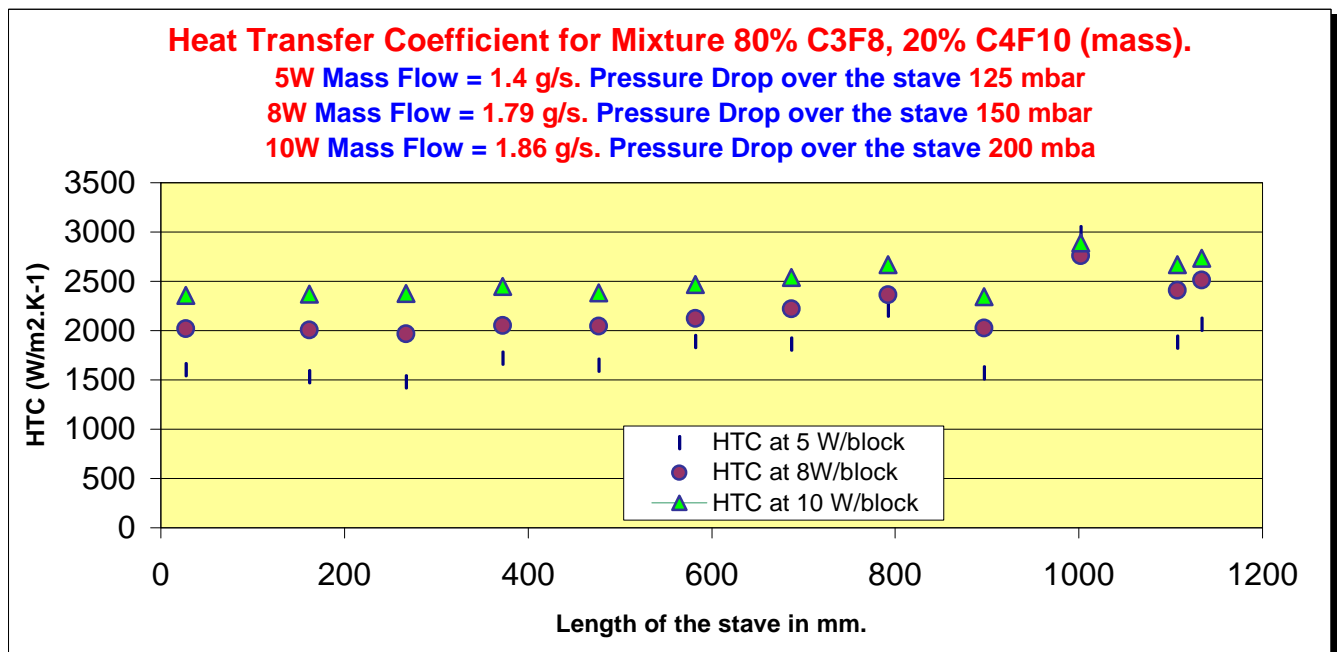

4.3.2. HTC measurement for C₃F₈ pure.

