

CTF 3 Commissioning 2006

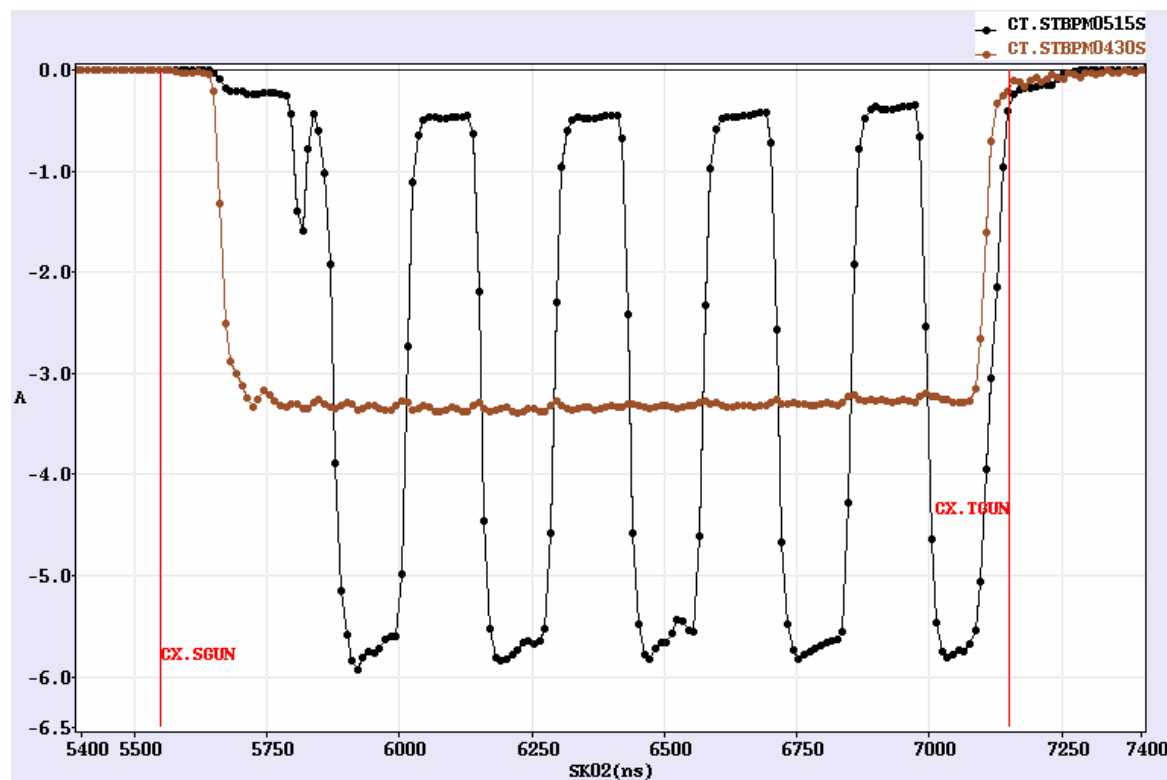

Frank Tecker - AB/OP

- Quad scan results
- Dispersion
- DL length



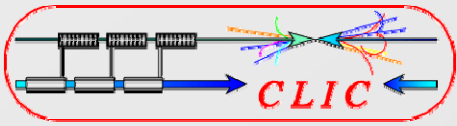

Results III

Quad Scans 2005

Injector was not optimised at the beginning.

Gain due to the optimisation of the injector (solenoid currents, steering)

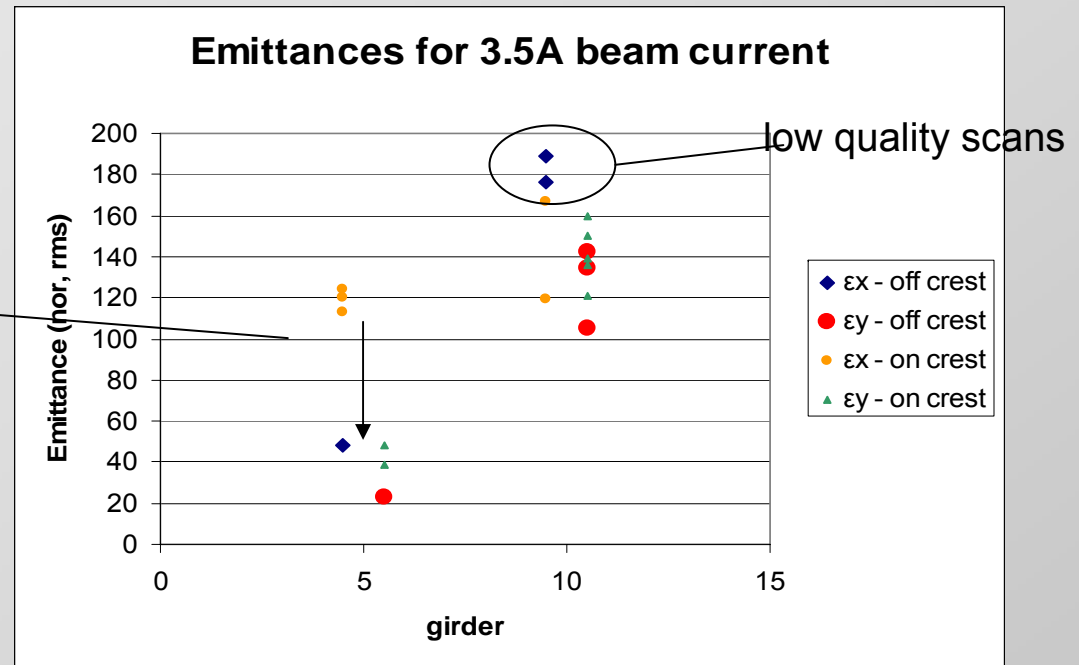

How to obtain a better understanding of the measurement results?

- (I) Girder 5: Scans with opposite polarity of quadrupoles to distinguish if the difference in horiz. and vert. emittance is a beam property or related to diagnostics.
- (II) - same magnification for beam diagnostic instrumentation in girder 5 and 10.
- use quadrupoles in girder 9 for quad scans.
- (III) Quadrupole scans at the end of the Linac, to obtain a better understanding of the measured emittance values.

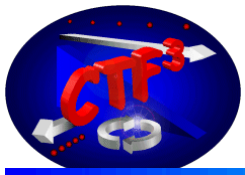

Quad Scans 2006



- > 90 scans done (documented in the logbook)
 - 3 on girder 5
 - 60 on girder 10
 - 27 in the CT line
- automatic program works well (averaging could be useful)
- variety of studies done
 - filters/screens
 - scan ranges
 - pulse length
 - transient subtraction

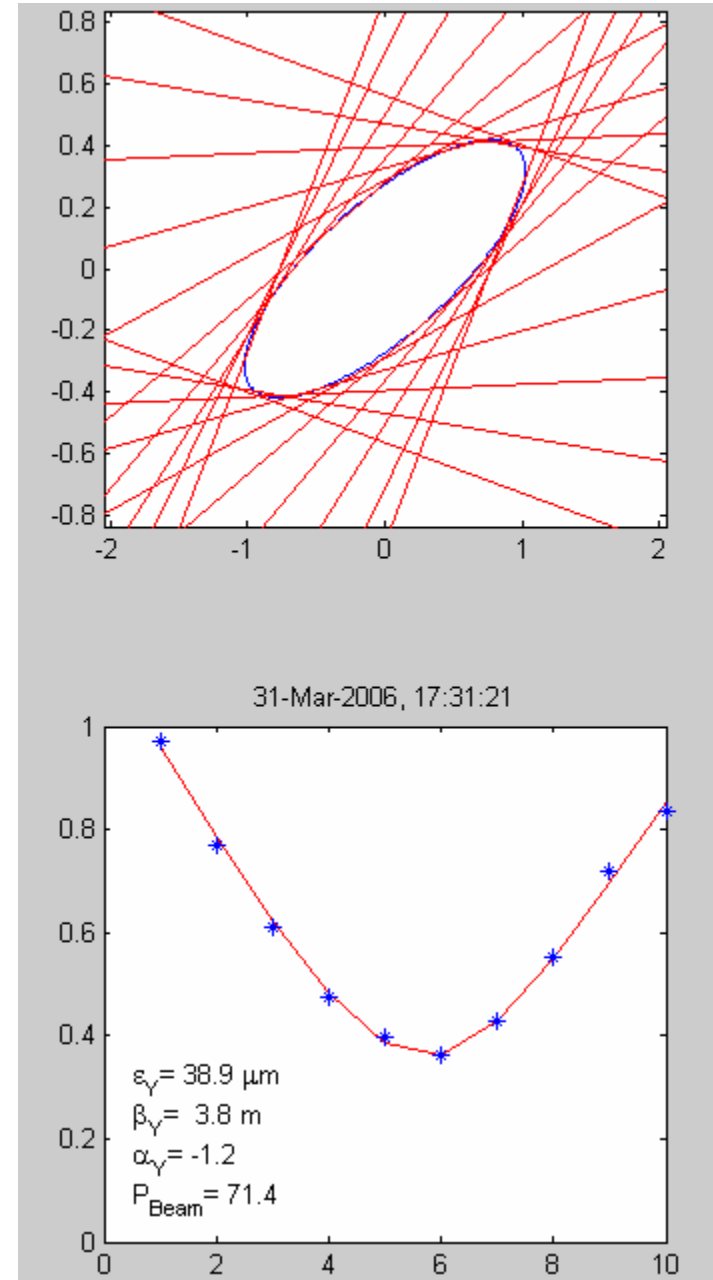

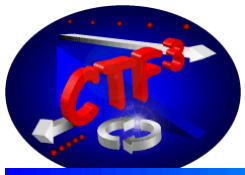

Transient subtraction



- image subtraction of long and short pulse for scans
- only the steady state part is analyzed

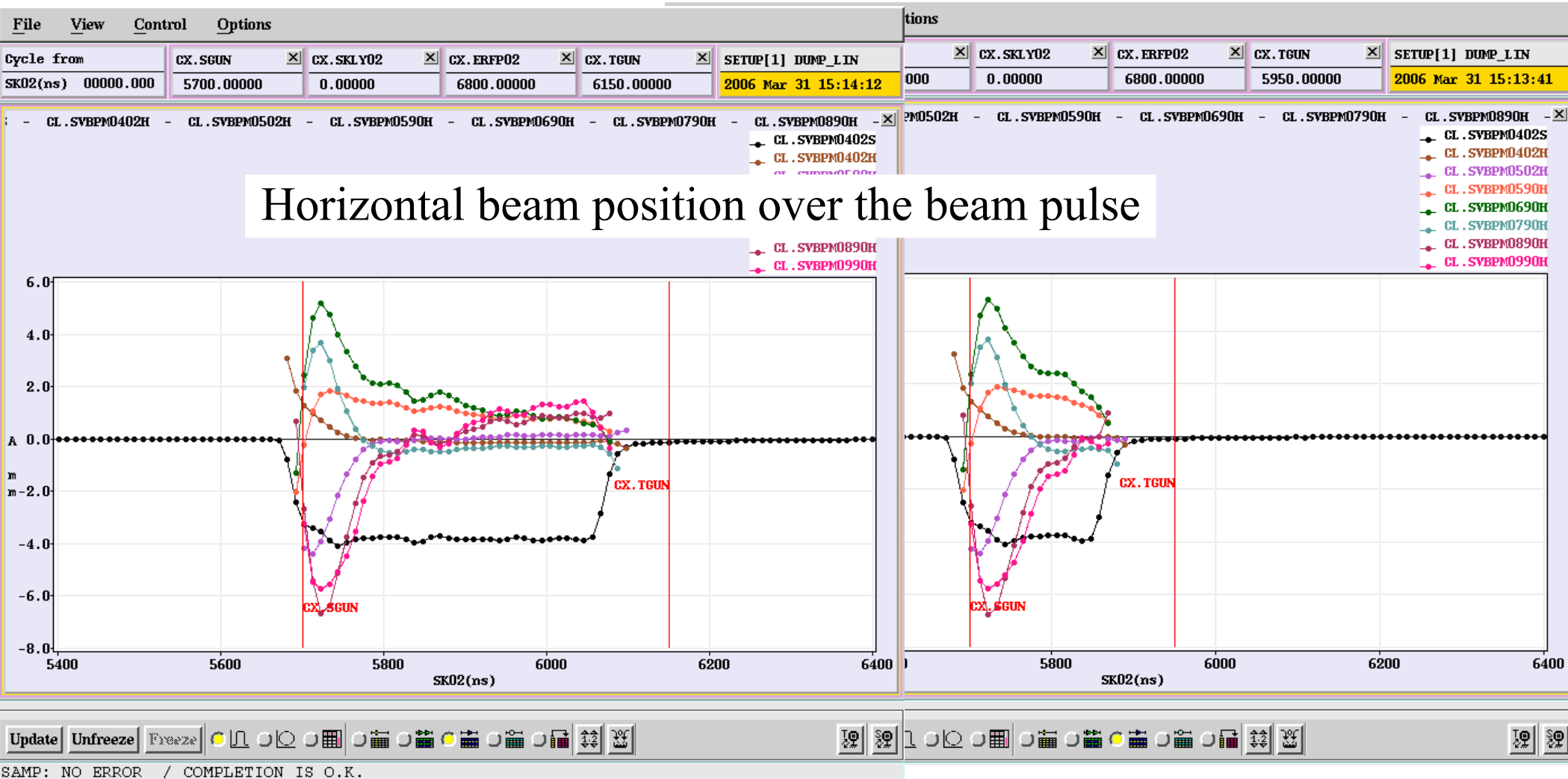

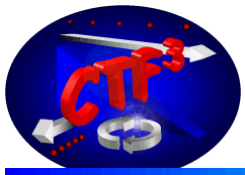

Quad Scans – Pulse Length



- Beam transient => Scan results dependant on pulse length
- image subtraction for long and short pulse for scans (700ns – 300ns)

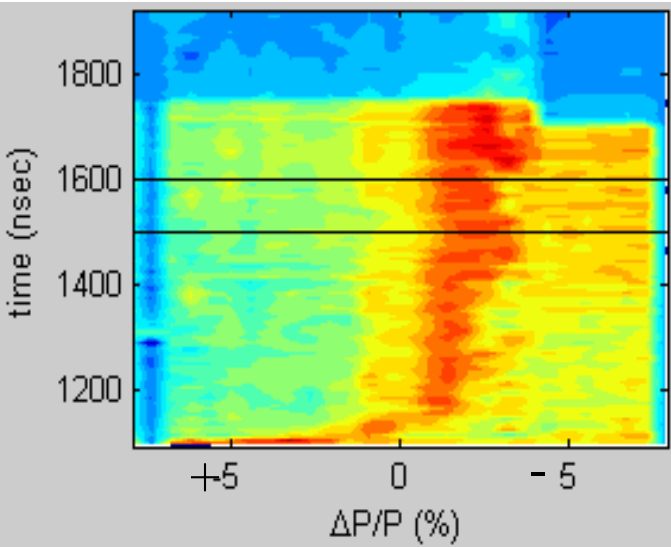

• Girder 10

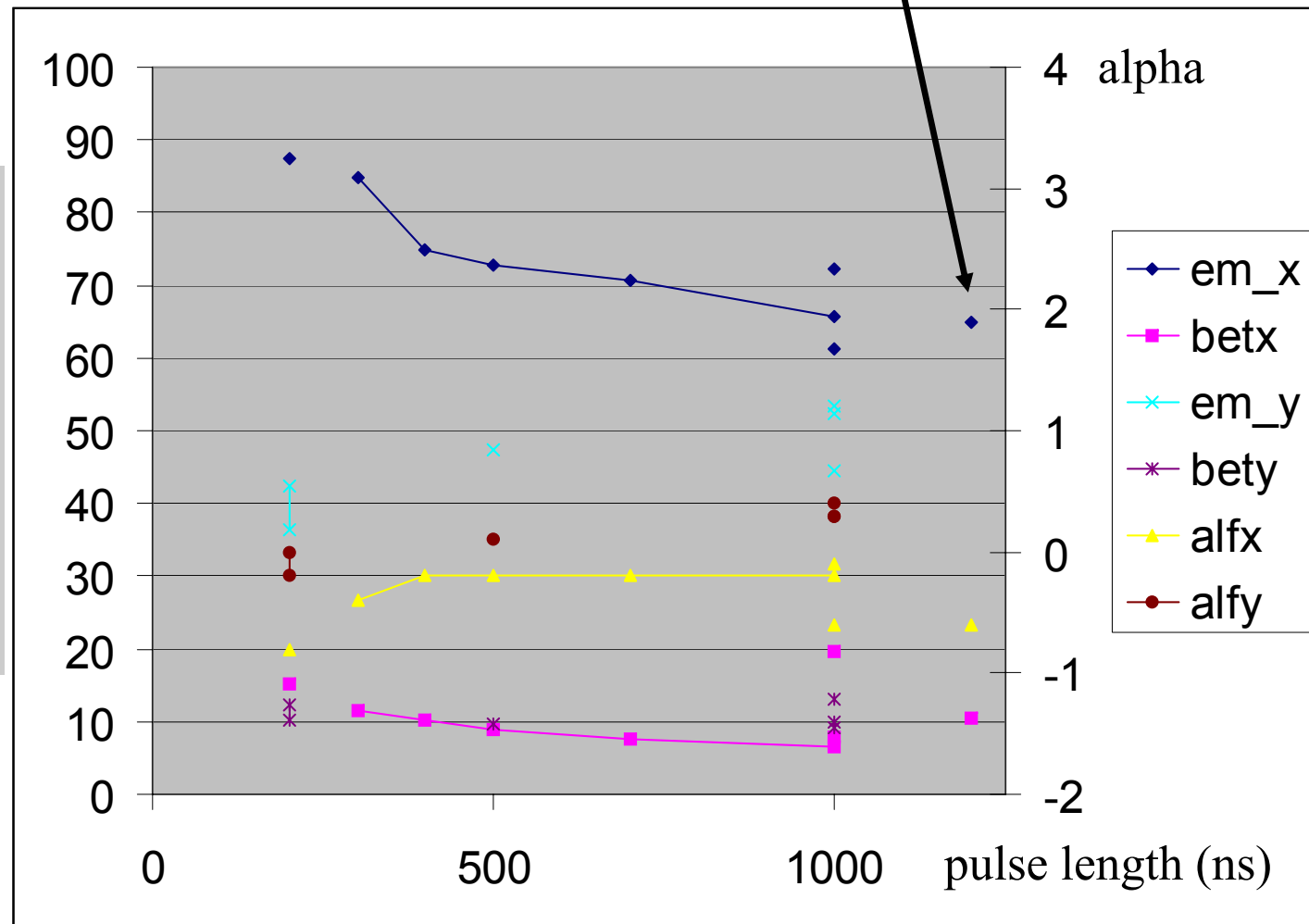

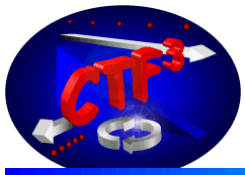

Emittance – data collection



- optical magnification on **girder 10** as on girder 5
=> we measure now also small $\epsilon < 50$ mm mrad in both planes

- **larger ϵ values in CT line**
still $\epsilon < 100$ μ mrad

higher energy
=> smaller beam
=> optical limit ?

- to be analyzed in detail...

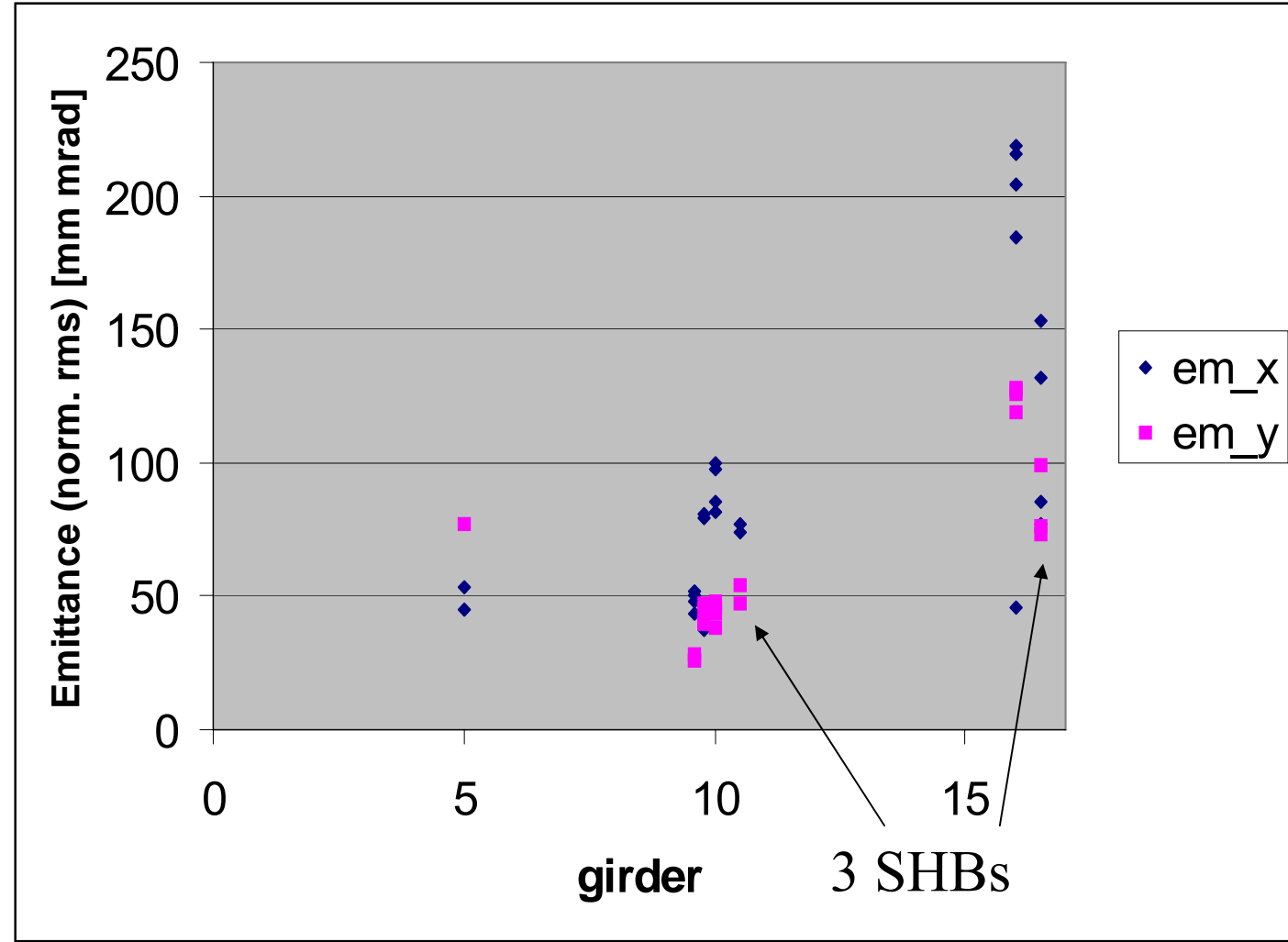

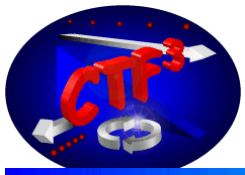

Optics matching (1)



- Linac rematched based on quad scan results on girder 10
- intermediate energies calculated from RF signals
- results in 71.4 MeV compared to 71 MeV measured

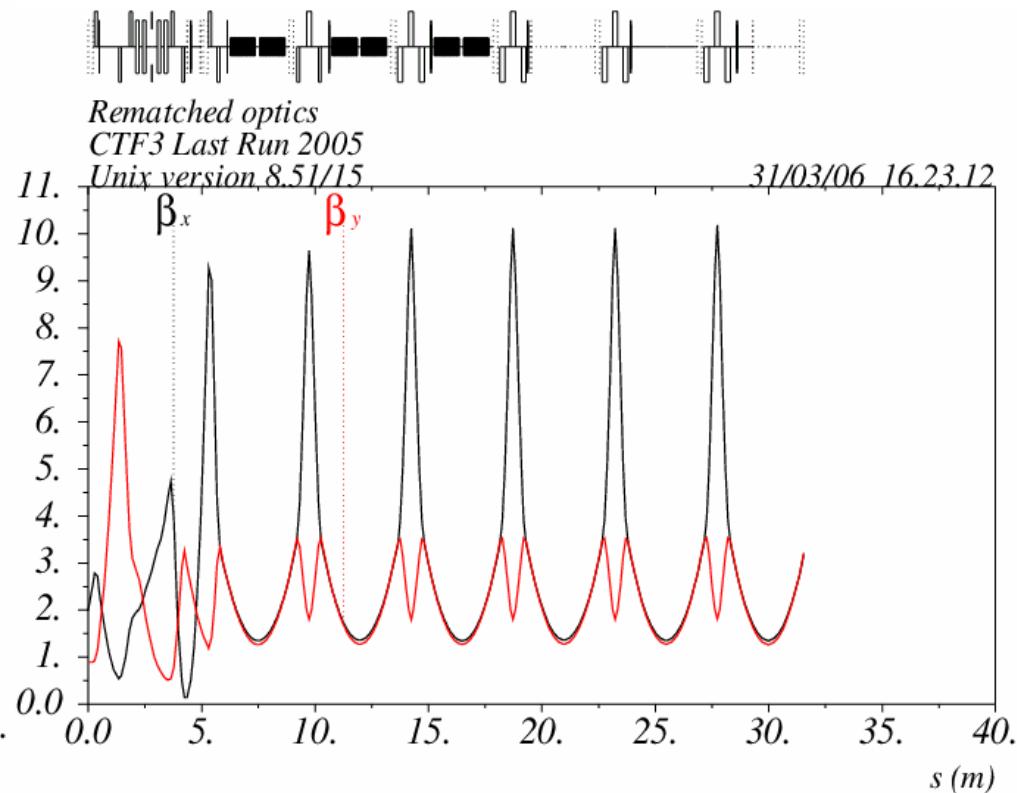
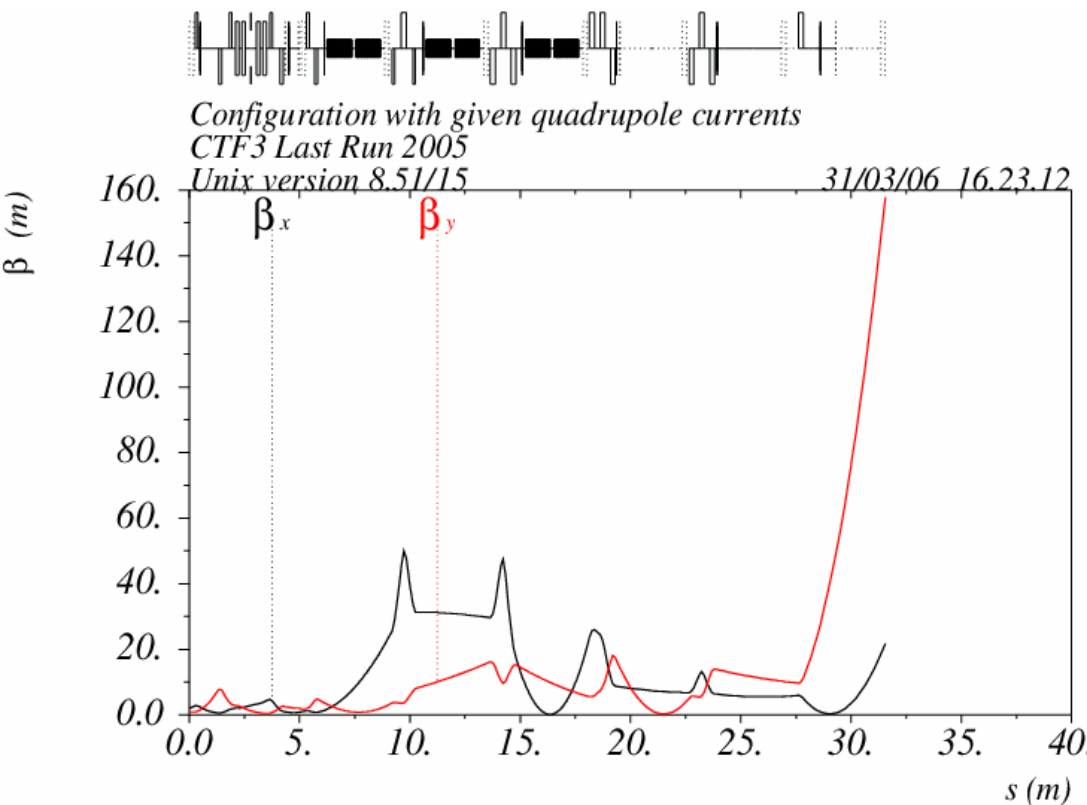

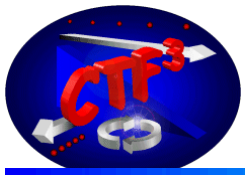

Optics matching (2)



- verified by new scans, expect $\beta=3.4\text{m}$ $\alpha=-1.2$
- measured:
 β : 2.3 – 4.5m
 α : -0.8 – -1.2
- => model well established
- also used for
 - linac downstream
 - CT line

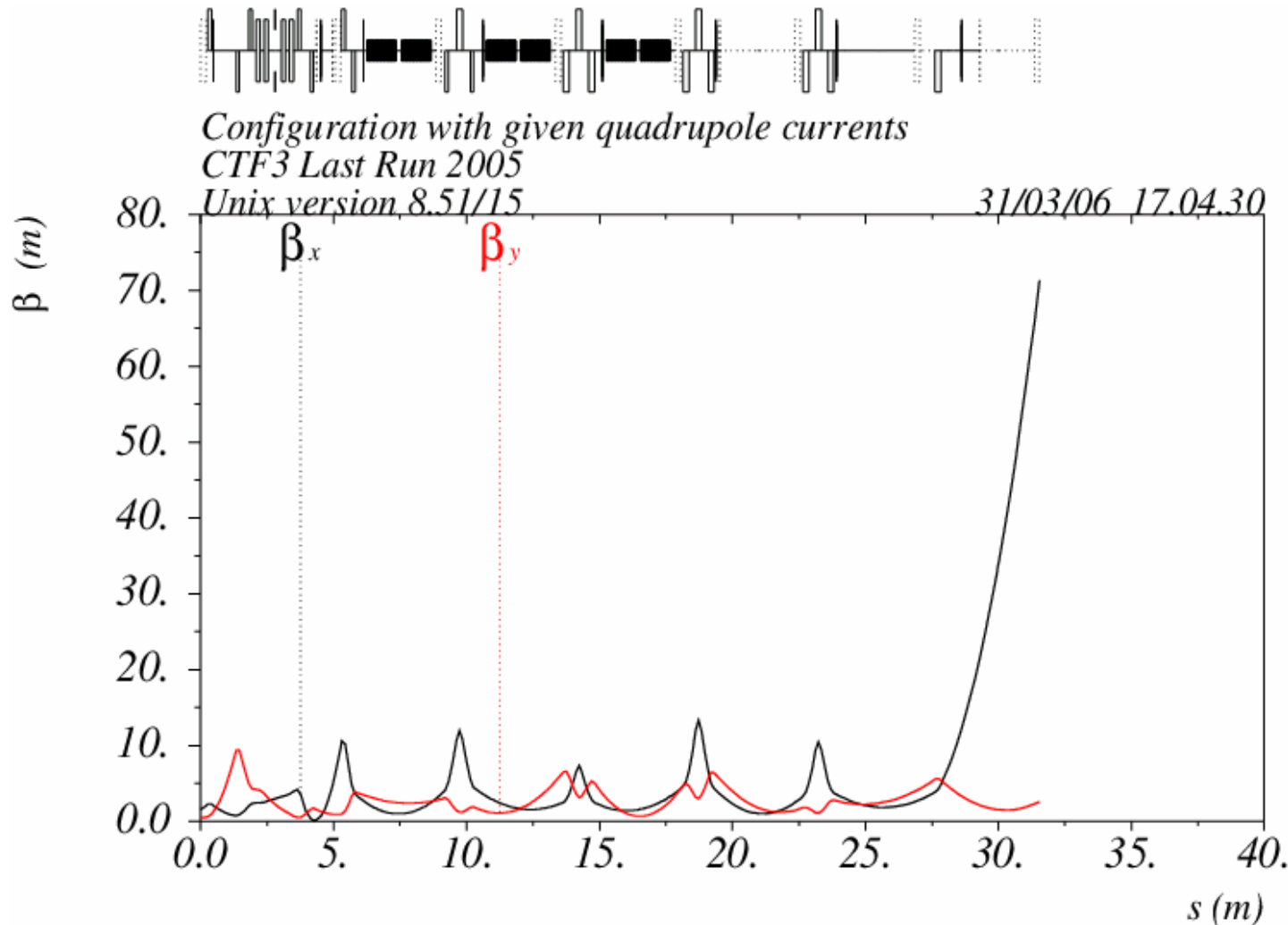

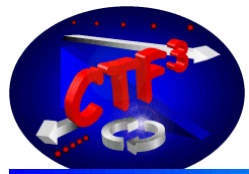

Dispersion Measurement (1)



- measure **reference trajectory** at nominal magnet settings
- **scale magnets** by small amount ($\sim 1\%$)
 - CT Line
 - Delay Loop
- observe **difference trajectory**
- $E = 101 \text{ MeV}$

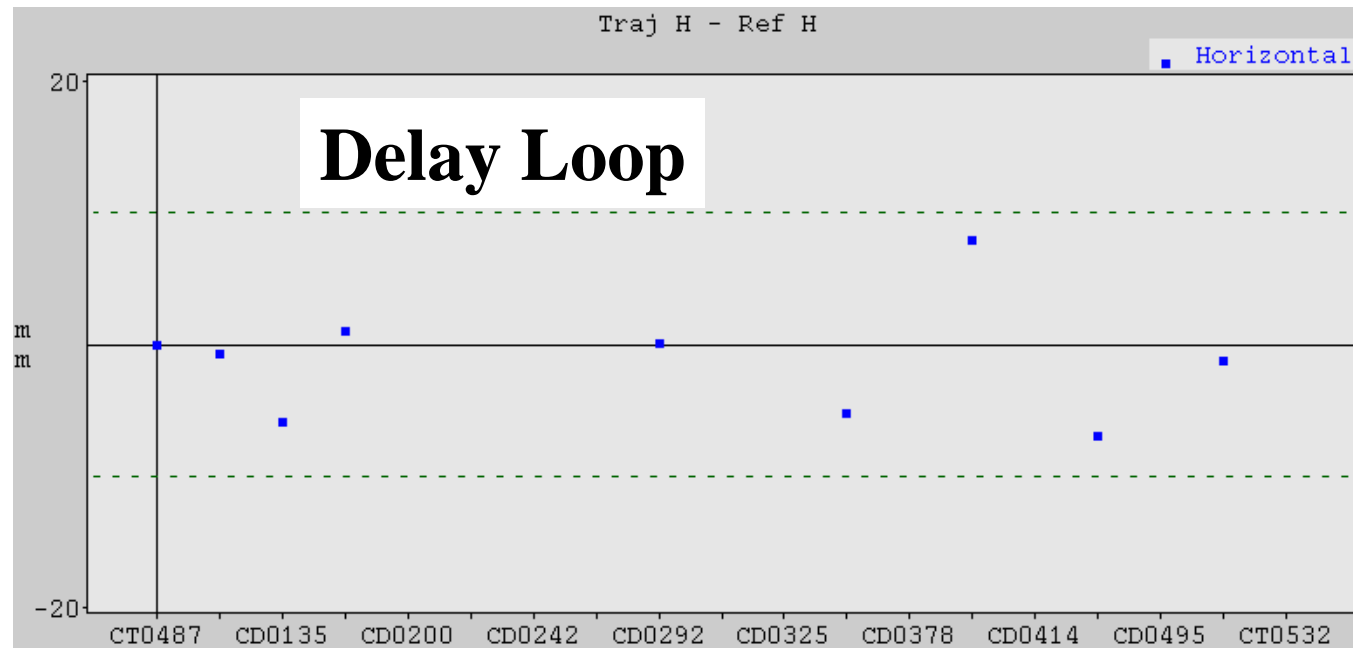
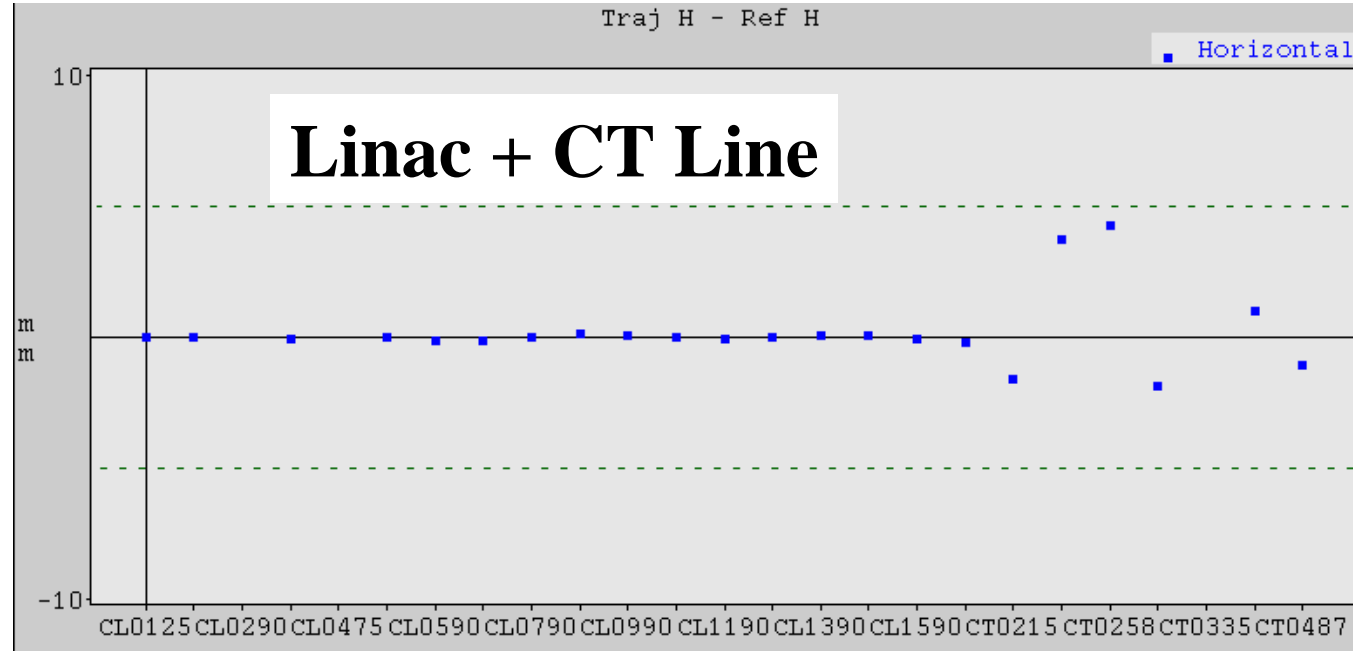

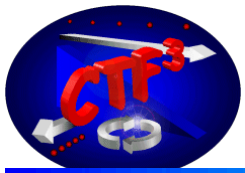

Dispersion Measurement (2)



Dispersion measurement 19.5.06 (-1%)

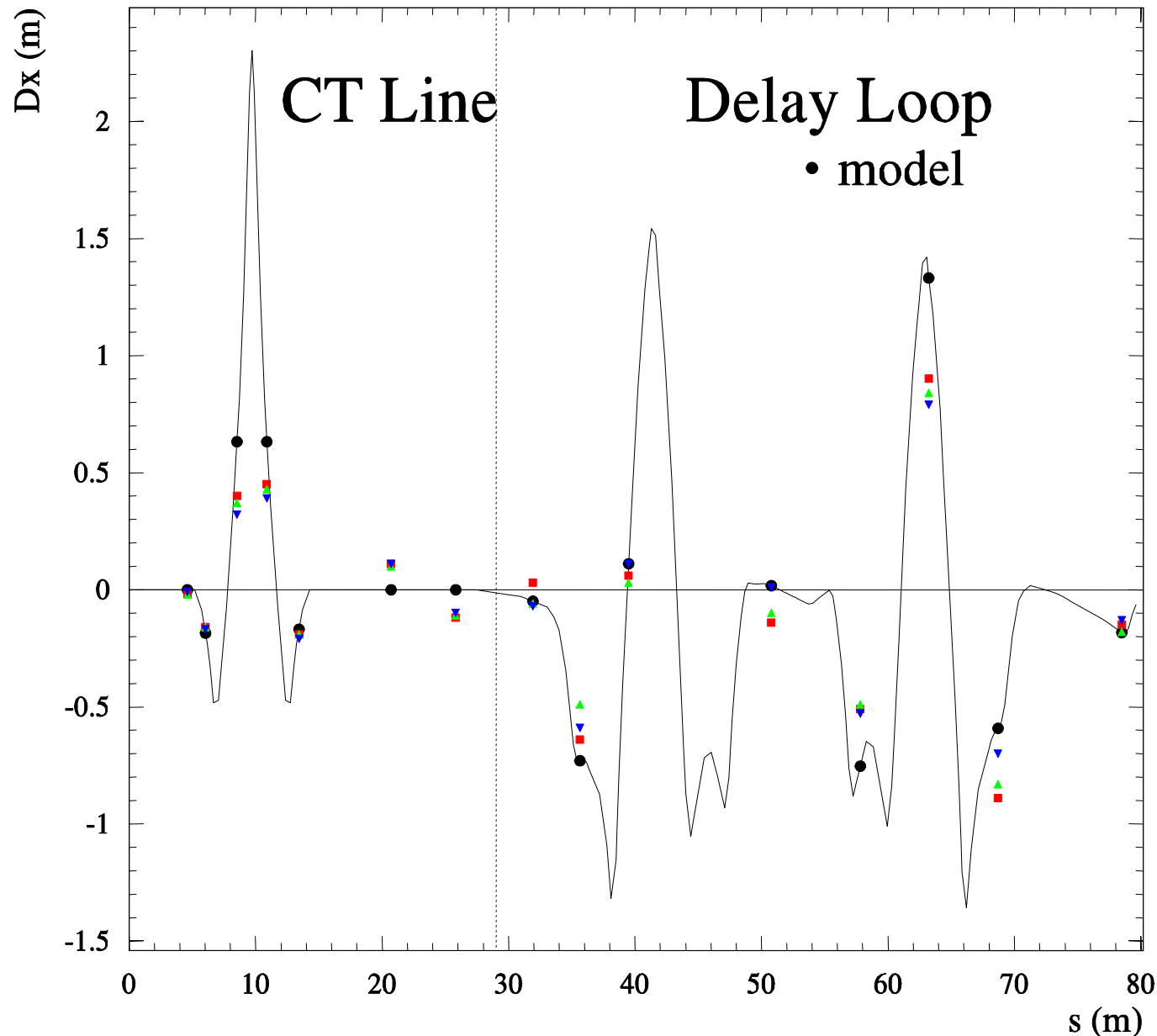

- relative good agreement between model and measurement
- worse in the second half of DL wiggler mismatch?

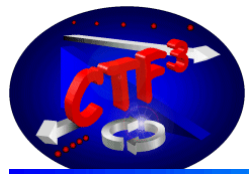

Dispersion Measurement (3)



Dispersion measurement 19.5.06 (-1% / +1%)

- overall, data for lower currents fits better
- energy lower than assumed
- more analysis to be done...

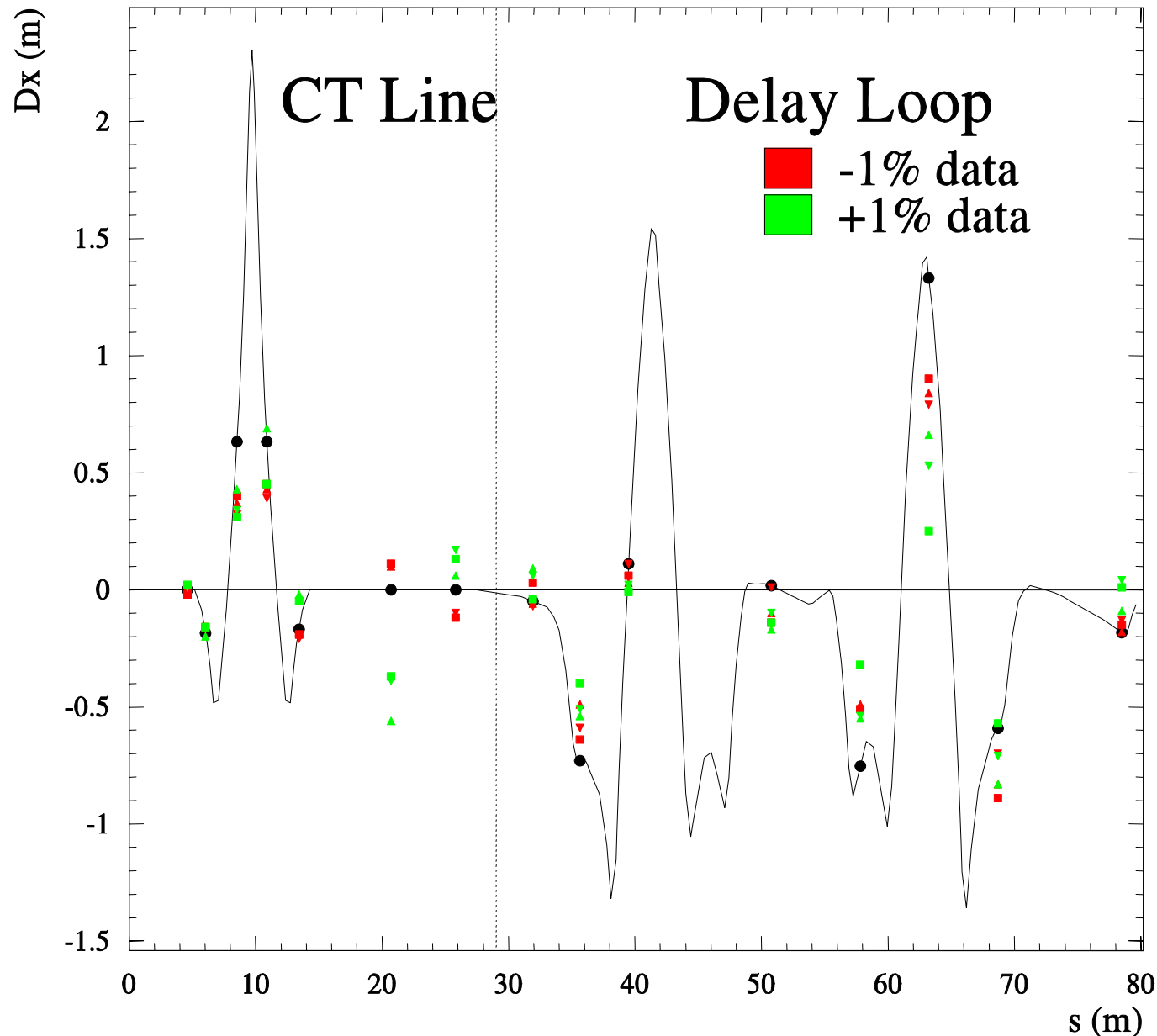

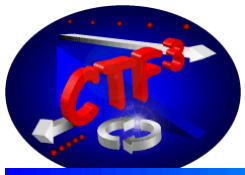

Residual dispersion



- Energy change in the linac and **difference trajectory**
- Source in the linac mainly **chicane on girder 04**
- Also in vertical plane !?
- **CT line chicane** another source

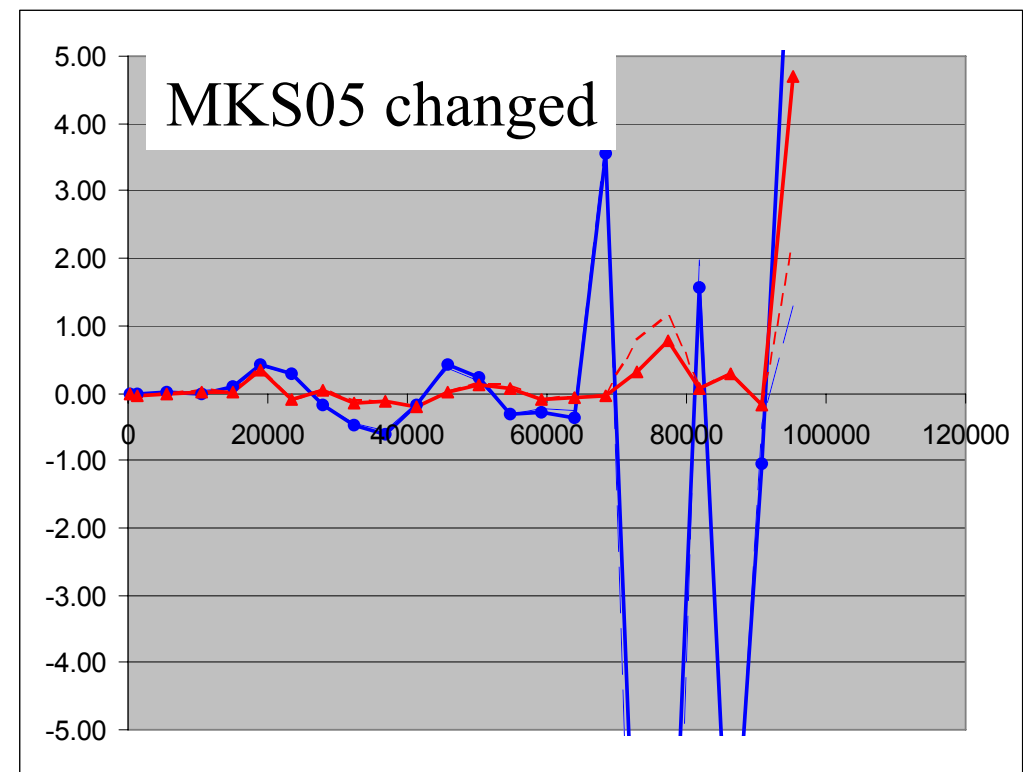
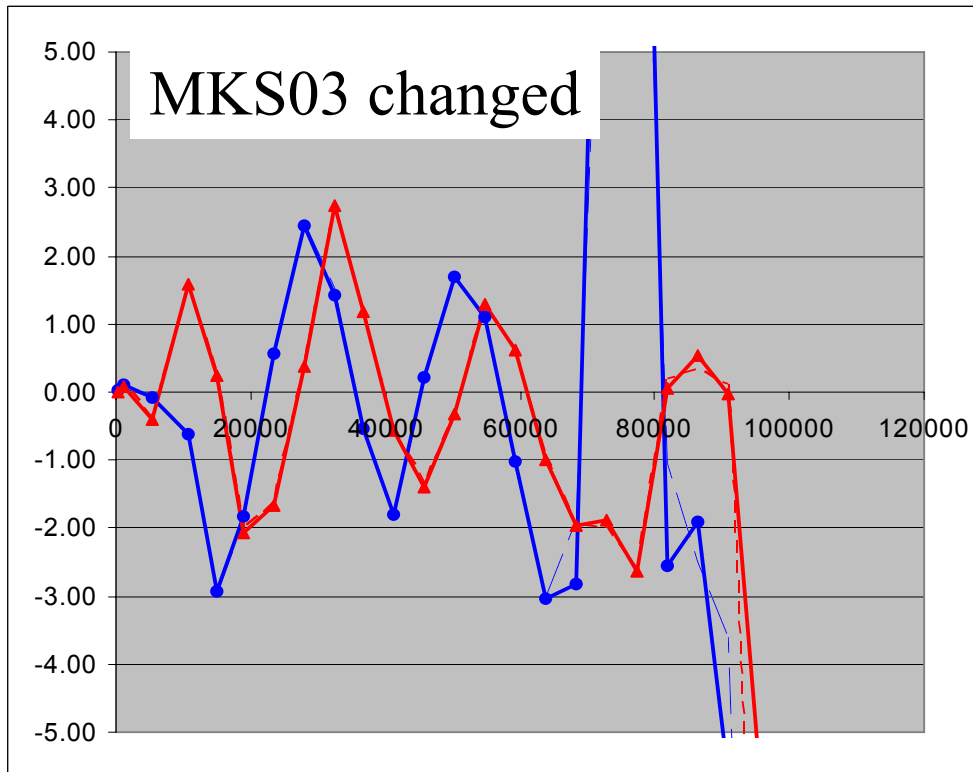

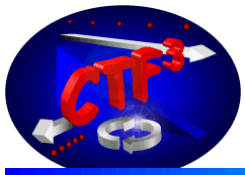

DL path length - BPR



- **DL wiggler** has path length tuning range of ~ 9 mm
- phase measurement on CT.**BPR0532** after DL
- change mixer (3 GHz) phase until signal close to 0 ($10^\circ \Leftrightarrow 2.8$ mm)
- \Rightarrow DL has the **correct length** within the tuning range

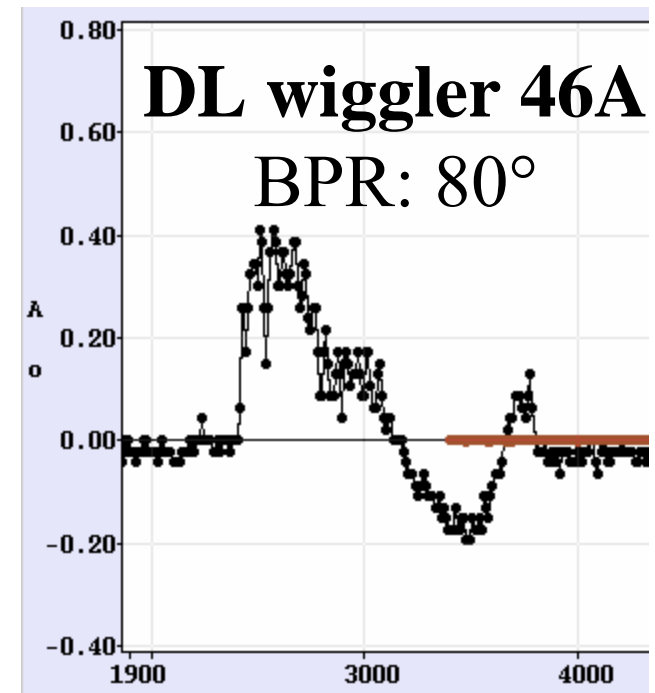
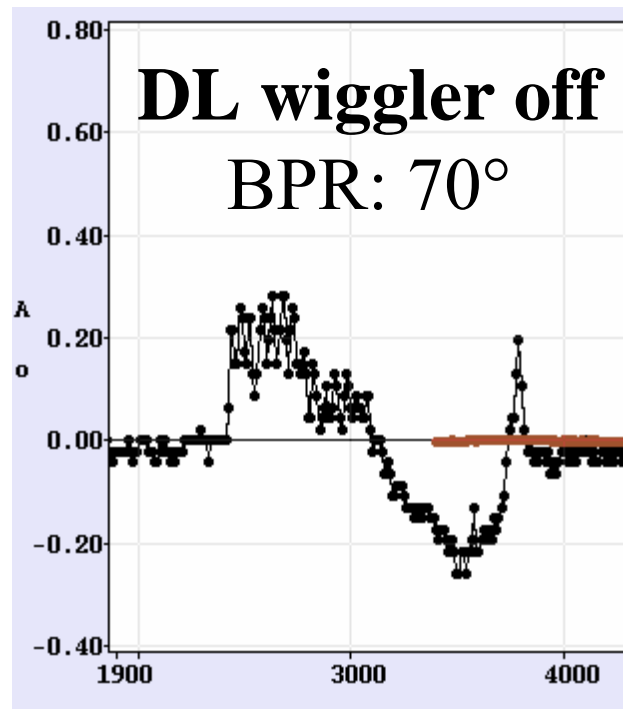
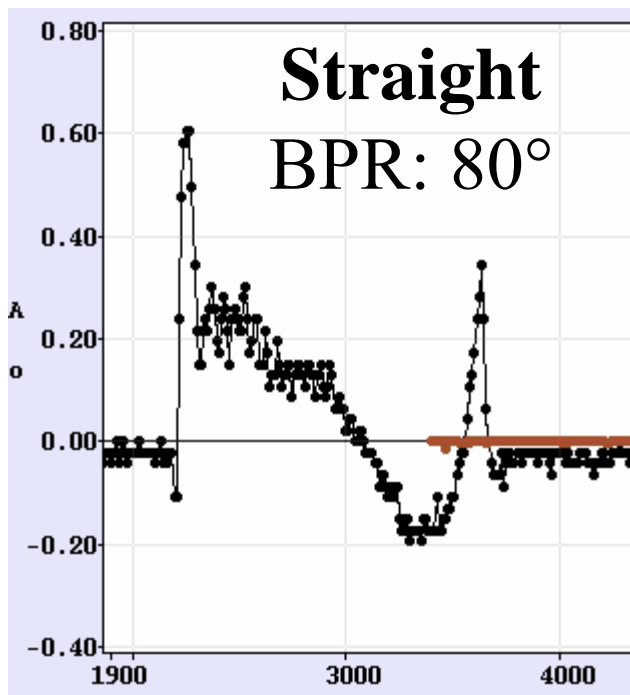



'To measure phase error in the RF bunch combination'

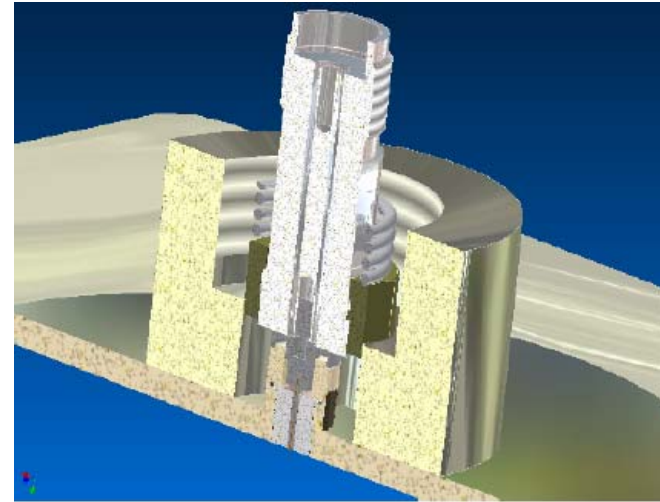
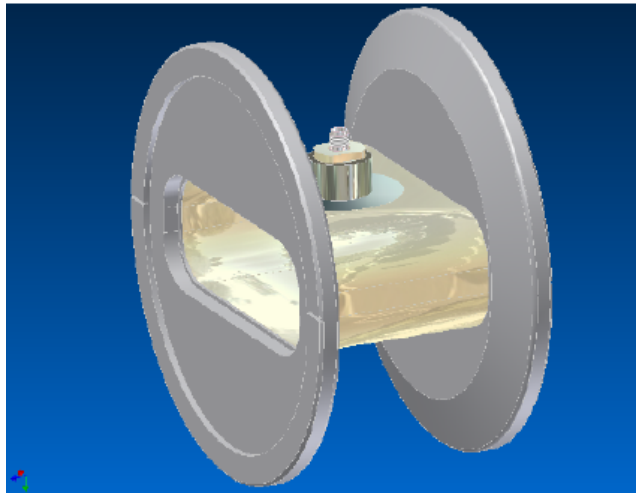

T.Lefevre

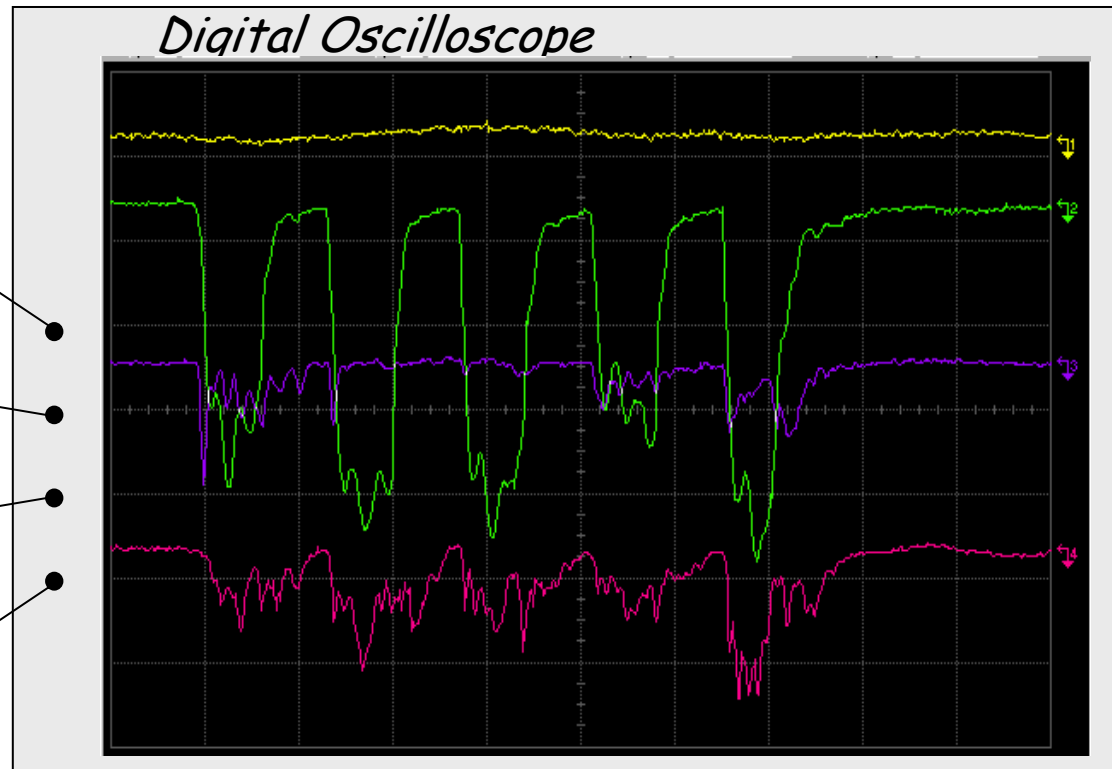
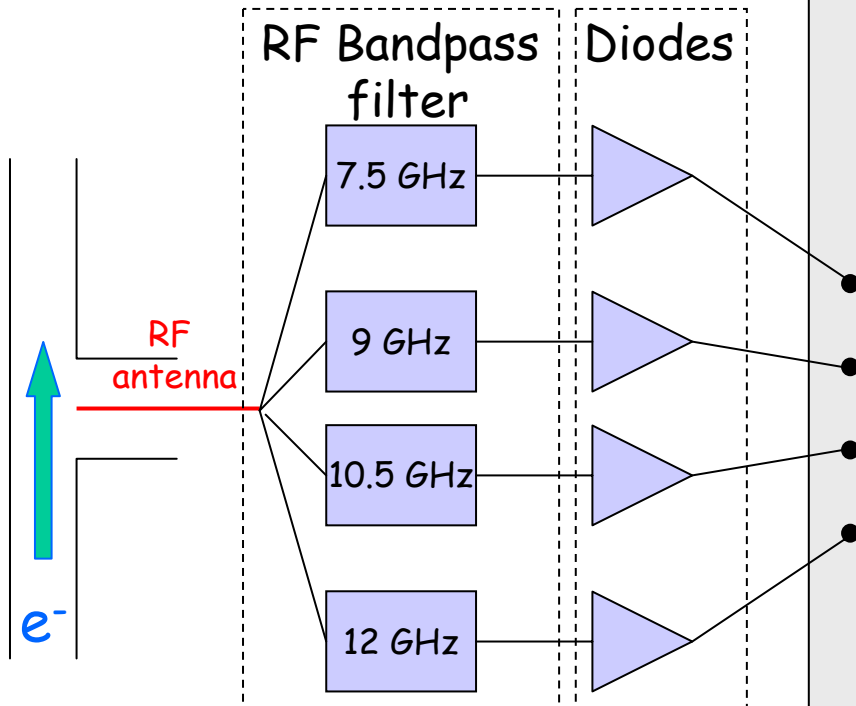



Pick-up signals with and without the combination (1.5 - 3 GHz)

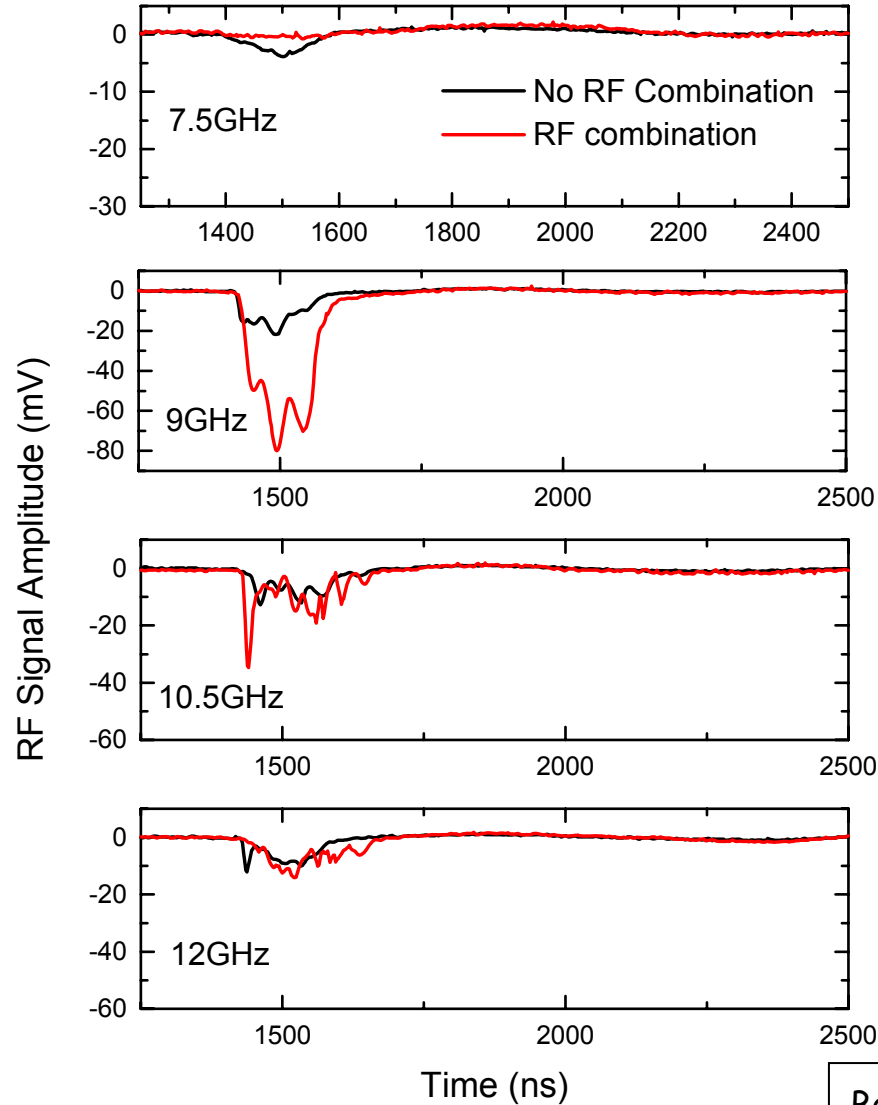

RF combination optimization with the Wiggler magnet

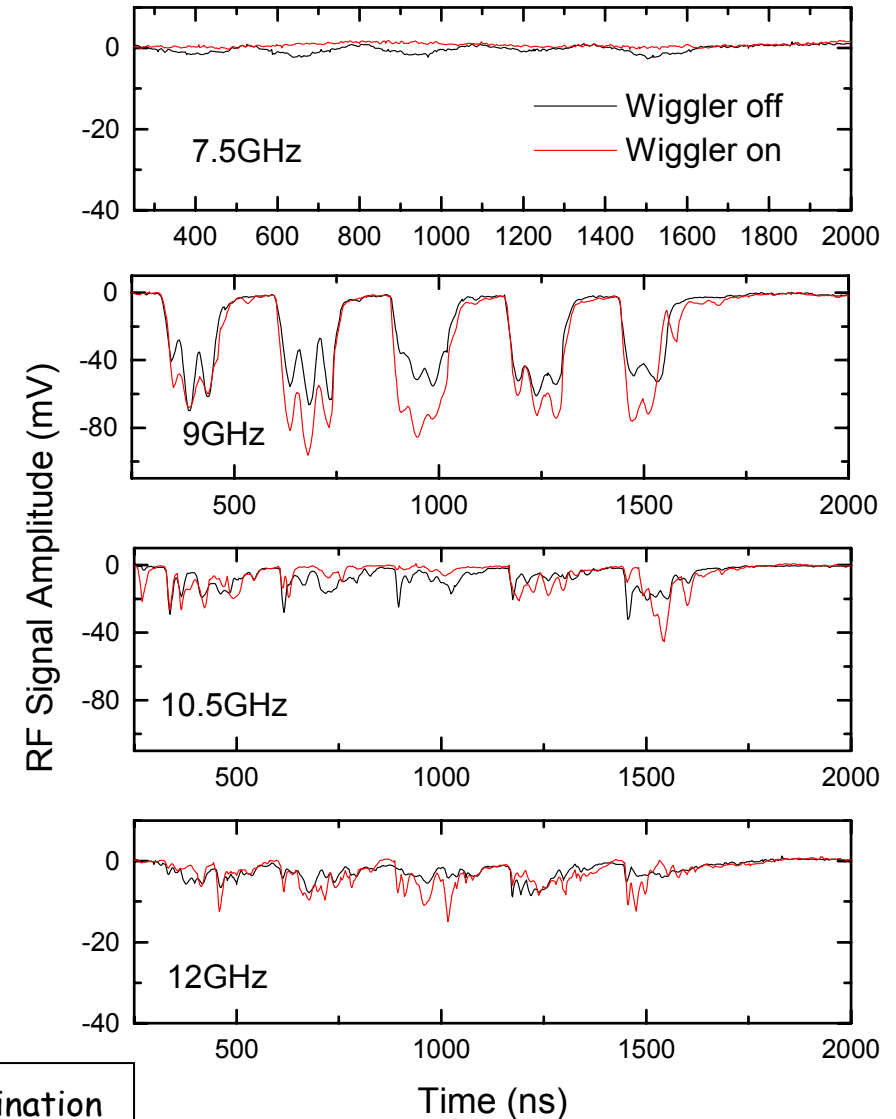

Better RF combination
• 7.5 & 10.5GHz
• 9 & 12 GHz

RF combination : 11th May 2006

T.Lefevre, C.Welsch

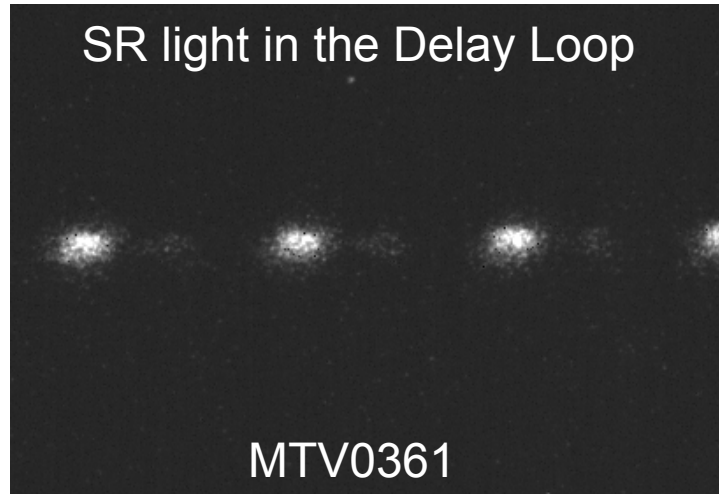

Sweep speed
250ps/mm

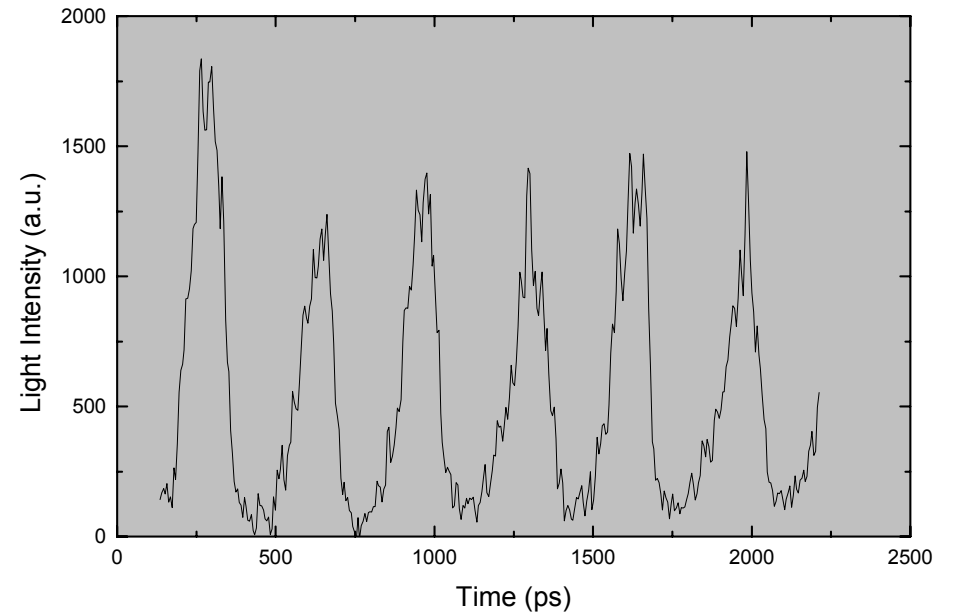
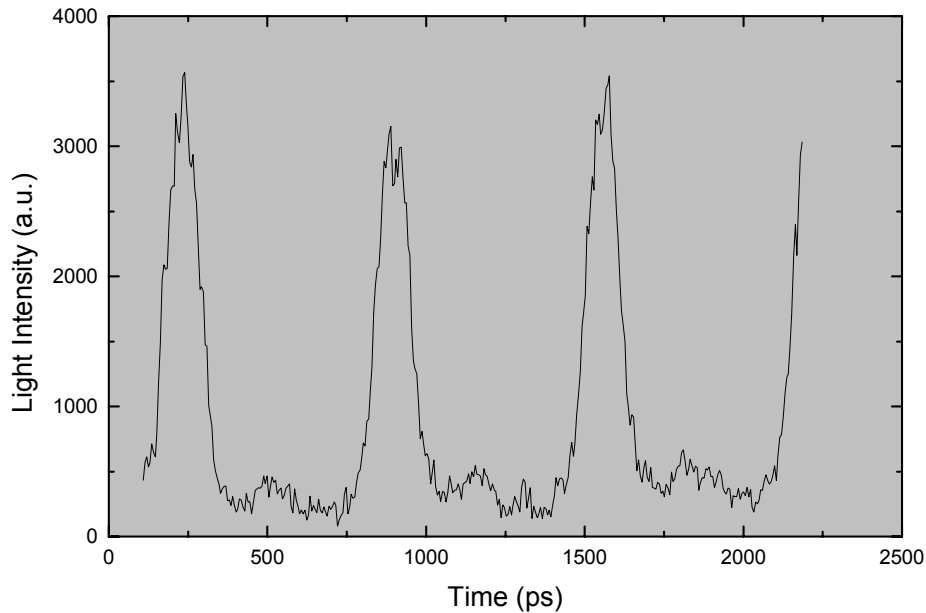
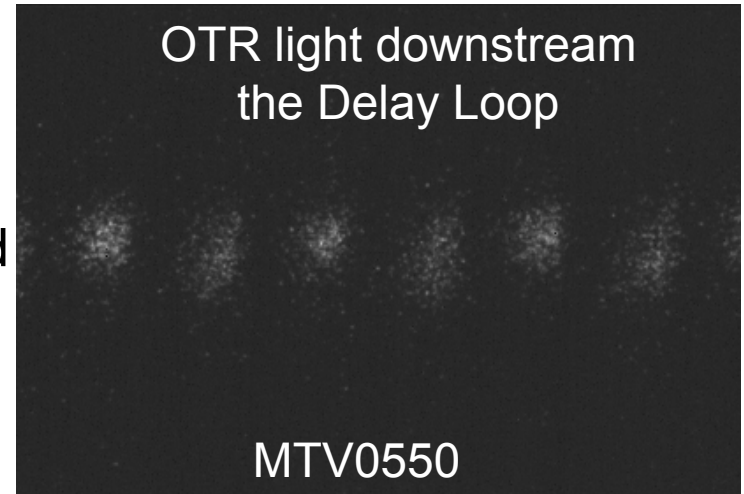

RF combination – Wiggler on & off : 12th May 2006

OTR light downstream the Delay Loop @MTV0550 Sweep speed 100ps/mm

C.Welsch, T.Lefevre

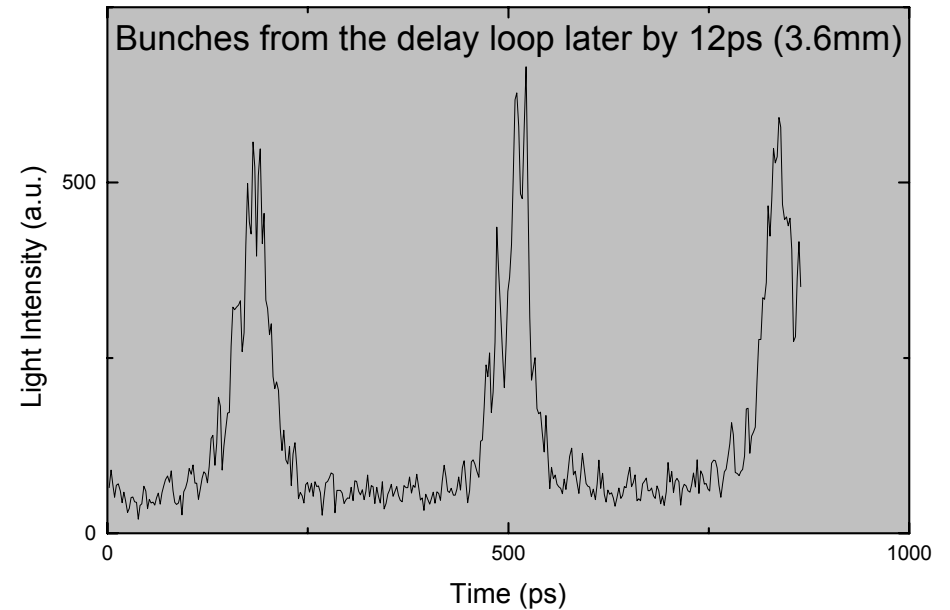
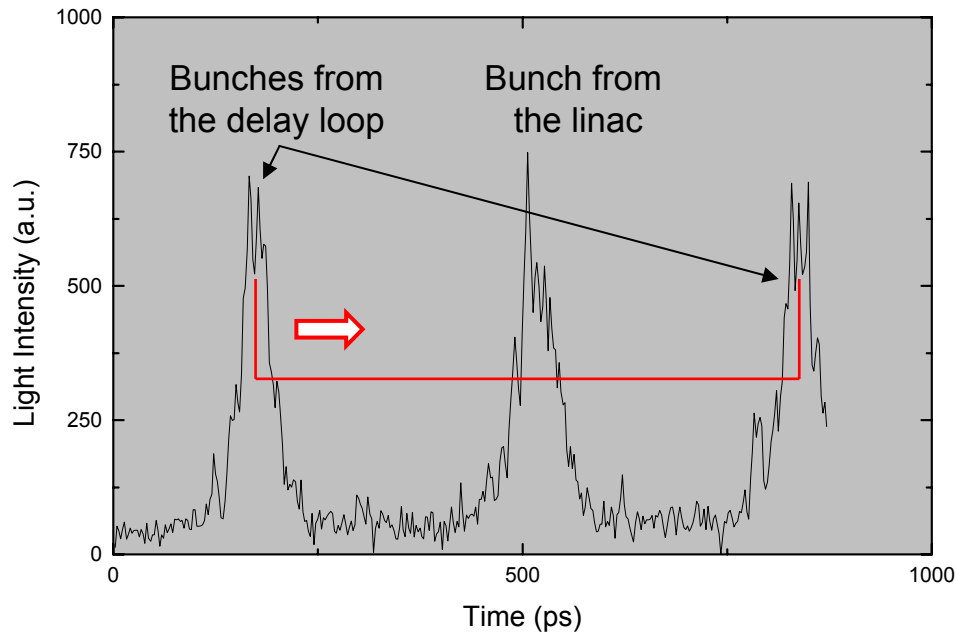
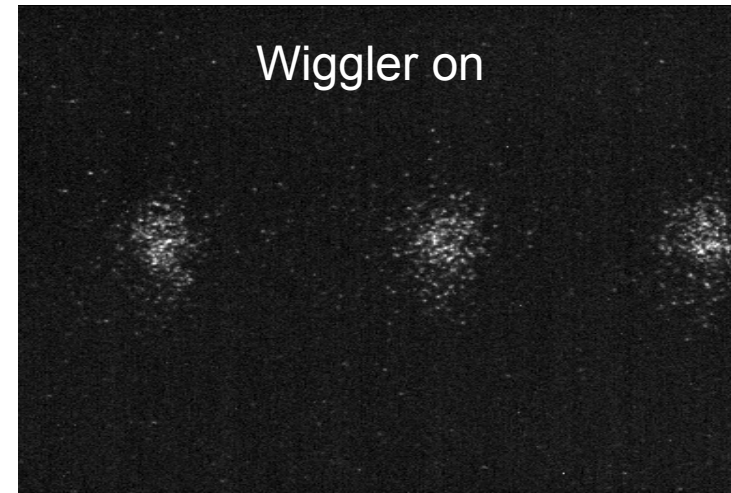
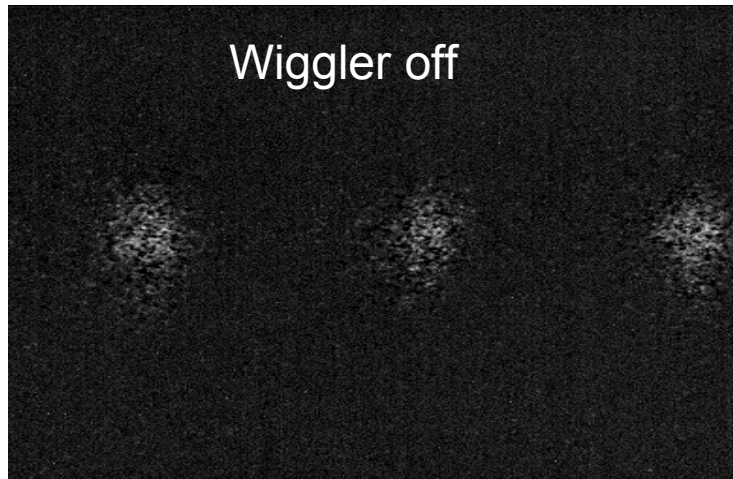



Conclusion



- Quad scan results show reasonable emittances
- Dispersion very close to expected values
- => optics well understood
- DL loop length correct

- trajectory measurements to be analyzed

- **verify magnet currents** from control system to magnet!

- Thanks to everyone involved!