

Thermal compensation of the optical RF delay line for the SPS transverse damper

A. Lassak
13. August 2015



13. Aug 2015

Thermally compensated optical delay line
Adam Lassak

0

Motivation

- SPS reference RF signals are generated in BA3
- SPS damper installed in BA2 (opposite direction than the beam is circulating)
- Ions use a sophisticated RF modulation scheme to accelerate “fixed frequency acceleration”
- Reference RF signals and the beam pickup signals have to arrive to the electronics at the same time

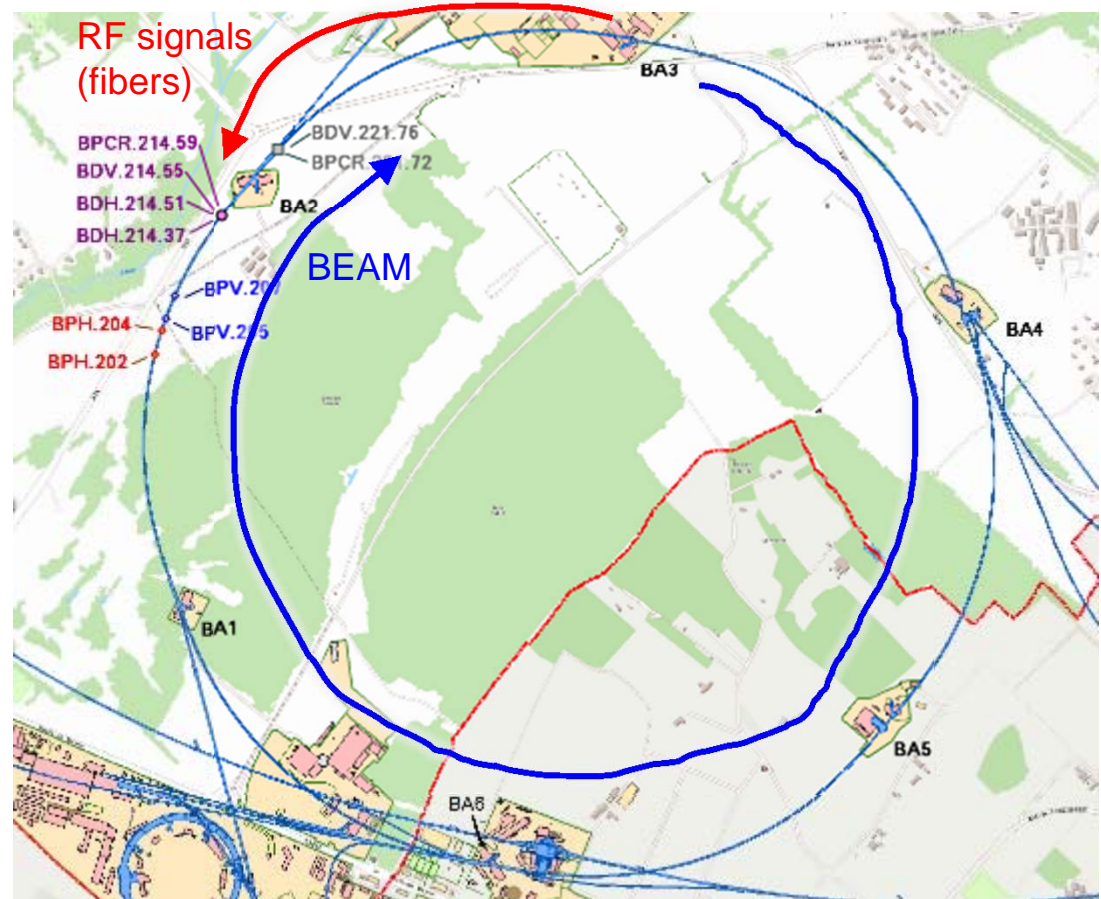

Motivation

- RF signals and the beam are synchronous in BA3
- They have to be made synchronous also in BA2

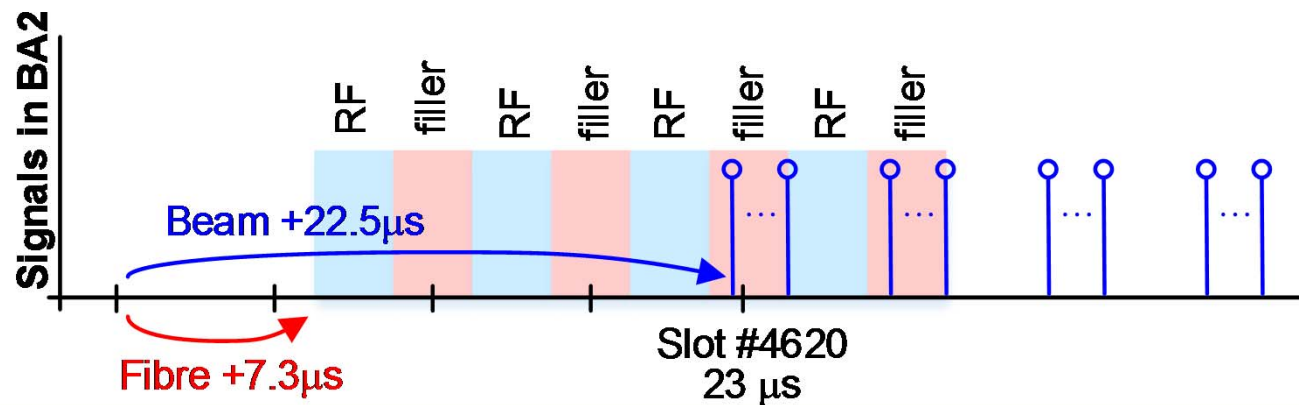
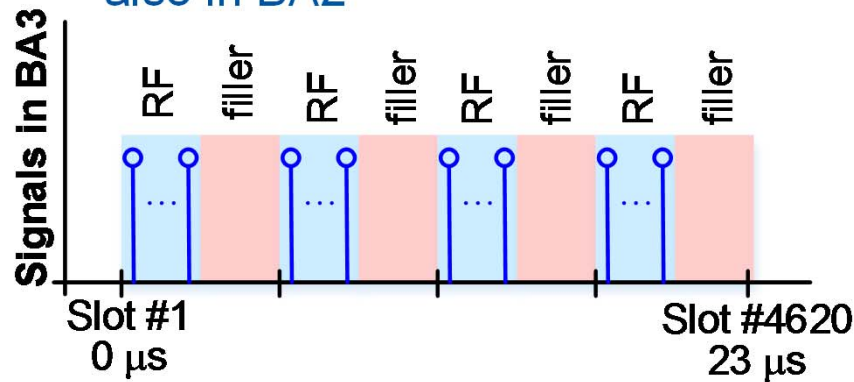
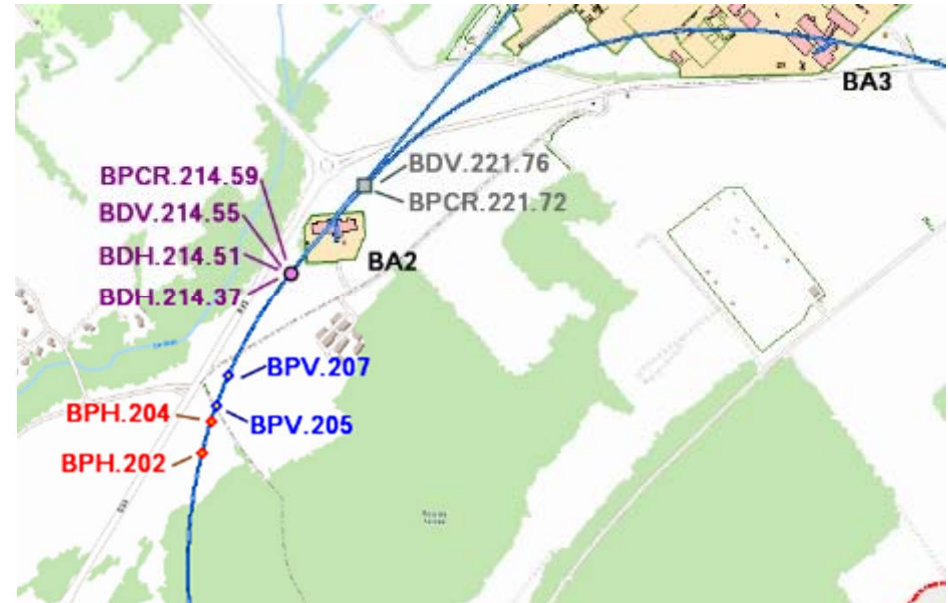

Fibre RF delay line

- Delays of several tens of μs can be easily obtained using analogue optical transceivers and single mode optical fibres

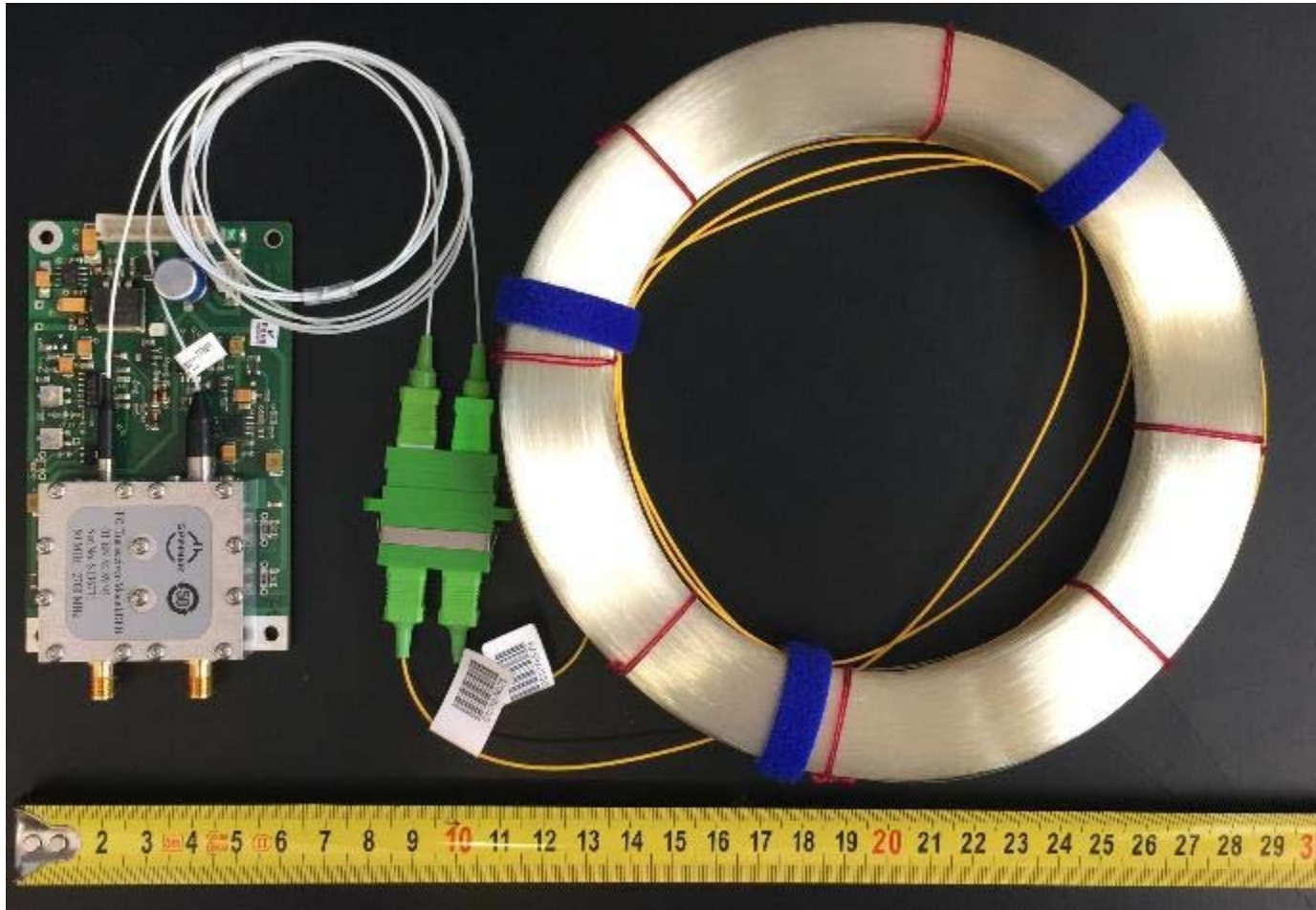

14.8 μs fibre coil
(3 km) with analogue
Spinner optical
transceiver

Purpose of fibre thermal compensation

- Fibre thermal drift is too large for our application, temperature effects have to be compensated
- Group delay of 3 km long (~14.8 μs) optical fibre was measured in a thermal chamber

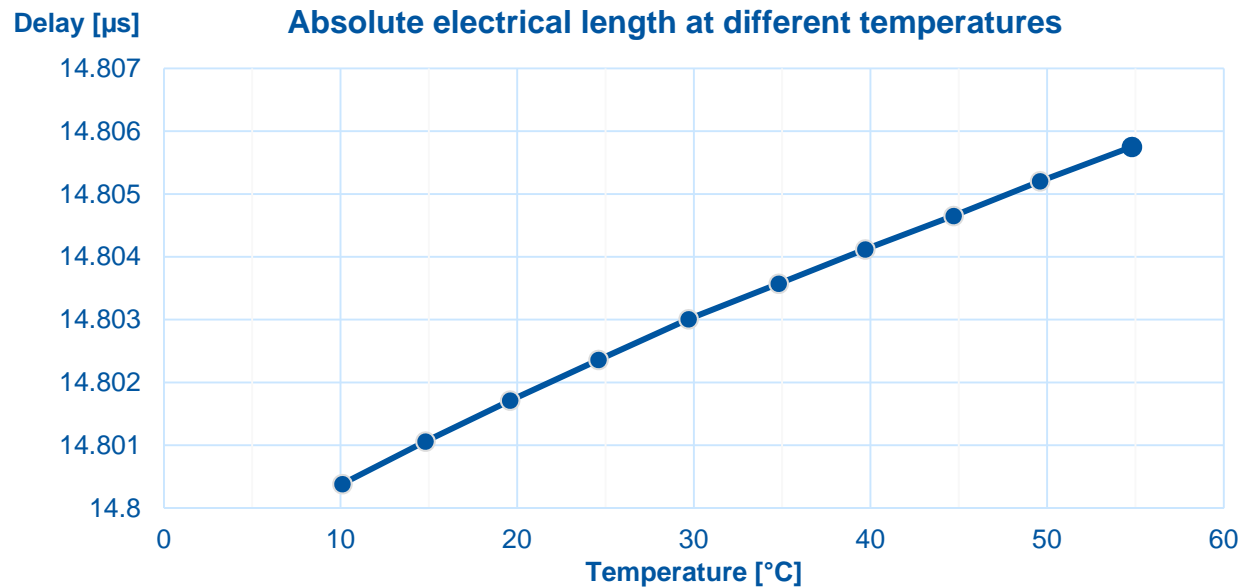

- Normalized polynomial fit:
 $\tau_{\text{dNORM}} = -3.265197 \times 10^{-8} t^2 + 1.015301 \times 10^{-5} t + 9.997133 \times 10^{-1} [1; ^{\circ}\text{C}]$

Requirements for temperature stability

- To meet the desired stability of group delay, temperature control must be very tight.
- Tolerated delay drift for correct damper operation is typically ± 125 ps.

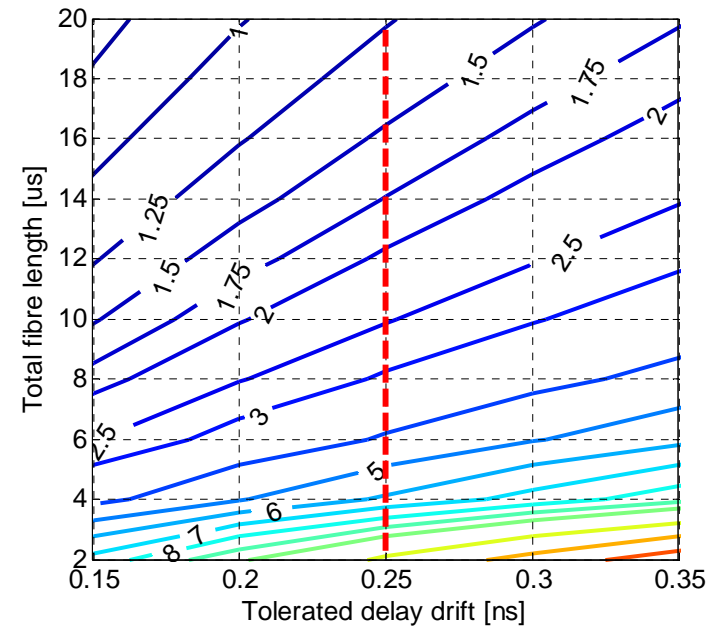
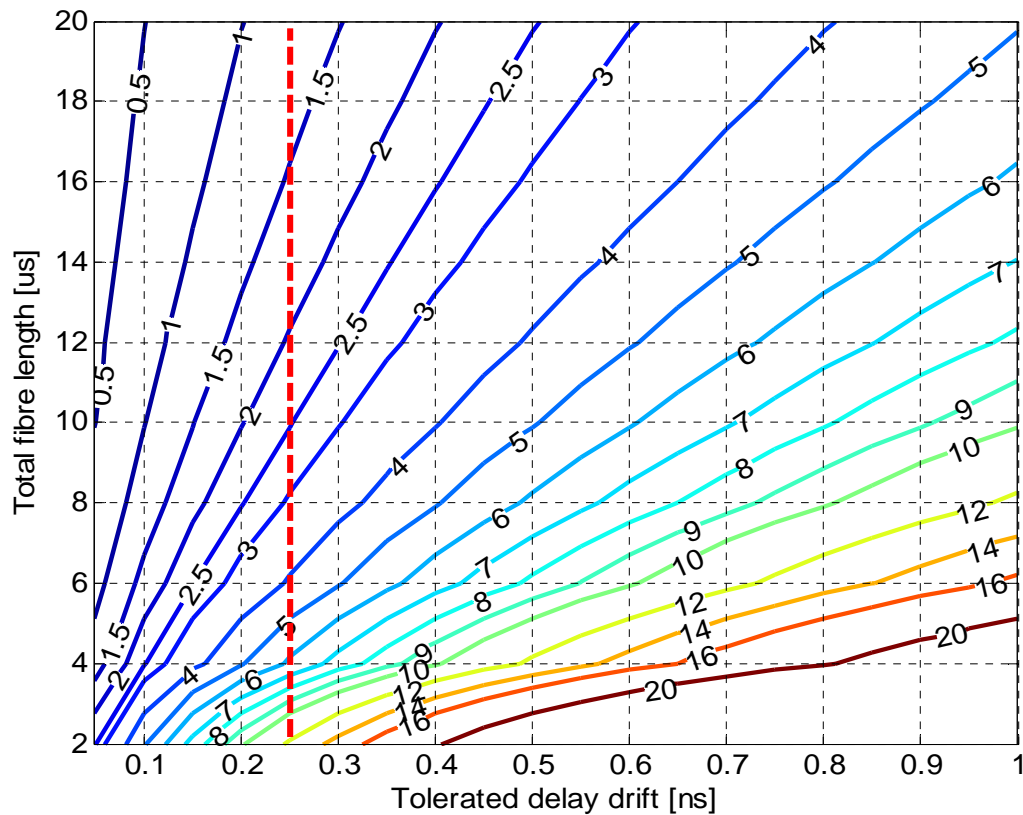

Maximum fibre temperature variation as a function of total fibre delay and tolerated delay drift.

Design of thermally insulated enclosure

- For practical reasons the fibre temperature is stabilized above the ambient
- Thermally insulated enclosure, housing 4 fibre coils have been designed
- To increase the thermal mass (and inertia), the enclosure is made of aluminium bars

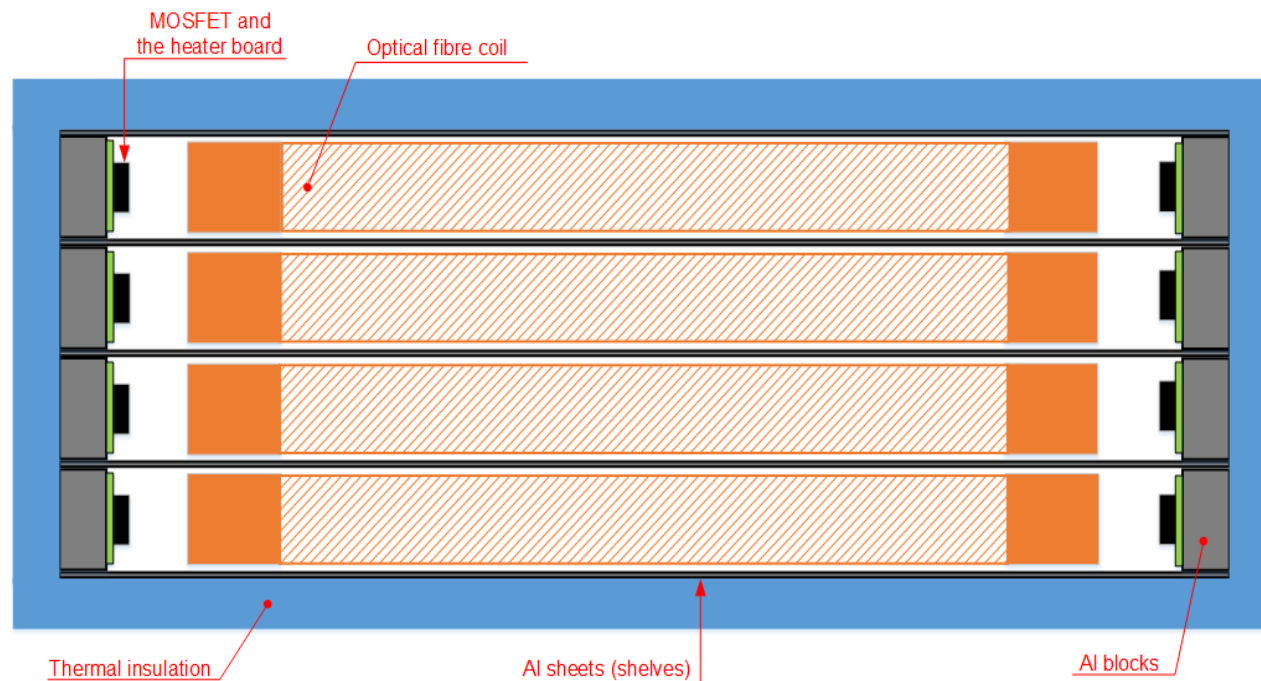

Design of thermally insulated enclosure

- Heating is provided by power MOSFETs mounted to the aluminium bars
- Each fibre slot has a heater board mounted on both sides
- Total 8 heater elements



- Each heater boards is equipped by a PT1000 temperature probe

Temperature controller

- Design goal was to reach a temperature stability better than $\pm 0.25\text{ }^{\circ}\text{C}$
- Controller is build as a fully analogue circuit
- Precision parts are used, such as PT1000, instrumentation amplifiers, voltage reference...
- To meet this requirements PI topology was used
- The topology was carefully designed such that temperature drifts in various parts of the circuit are cancelling-out

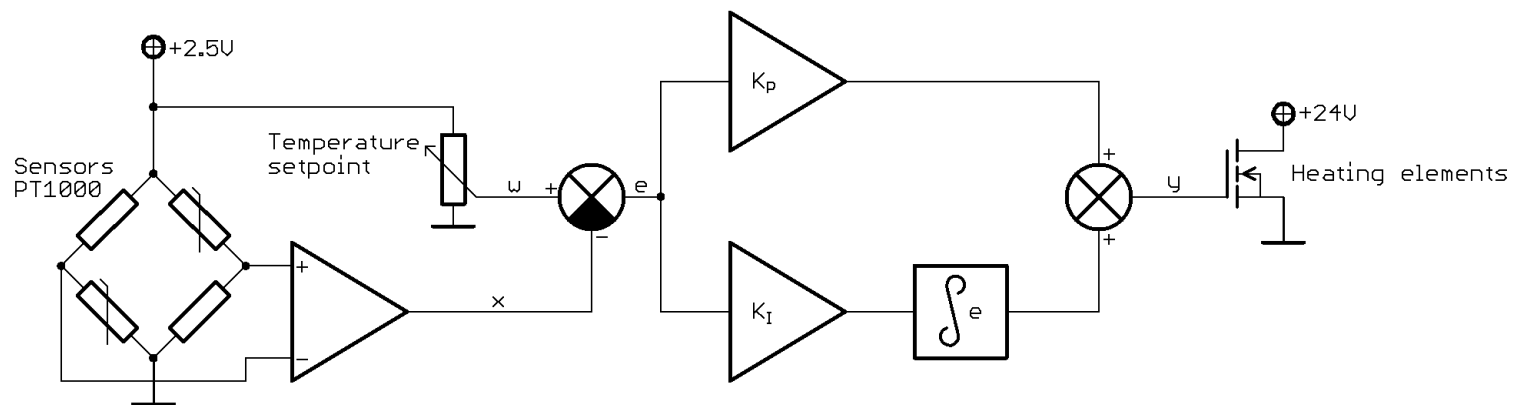

Controller test circuit

- For testing the performance of design controller prototype was build

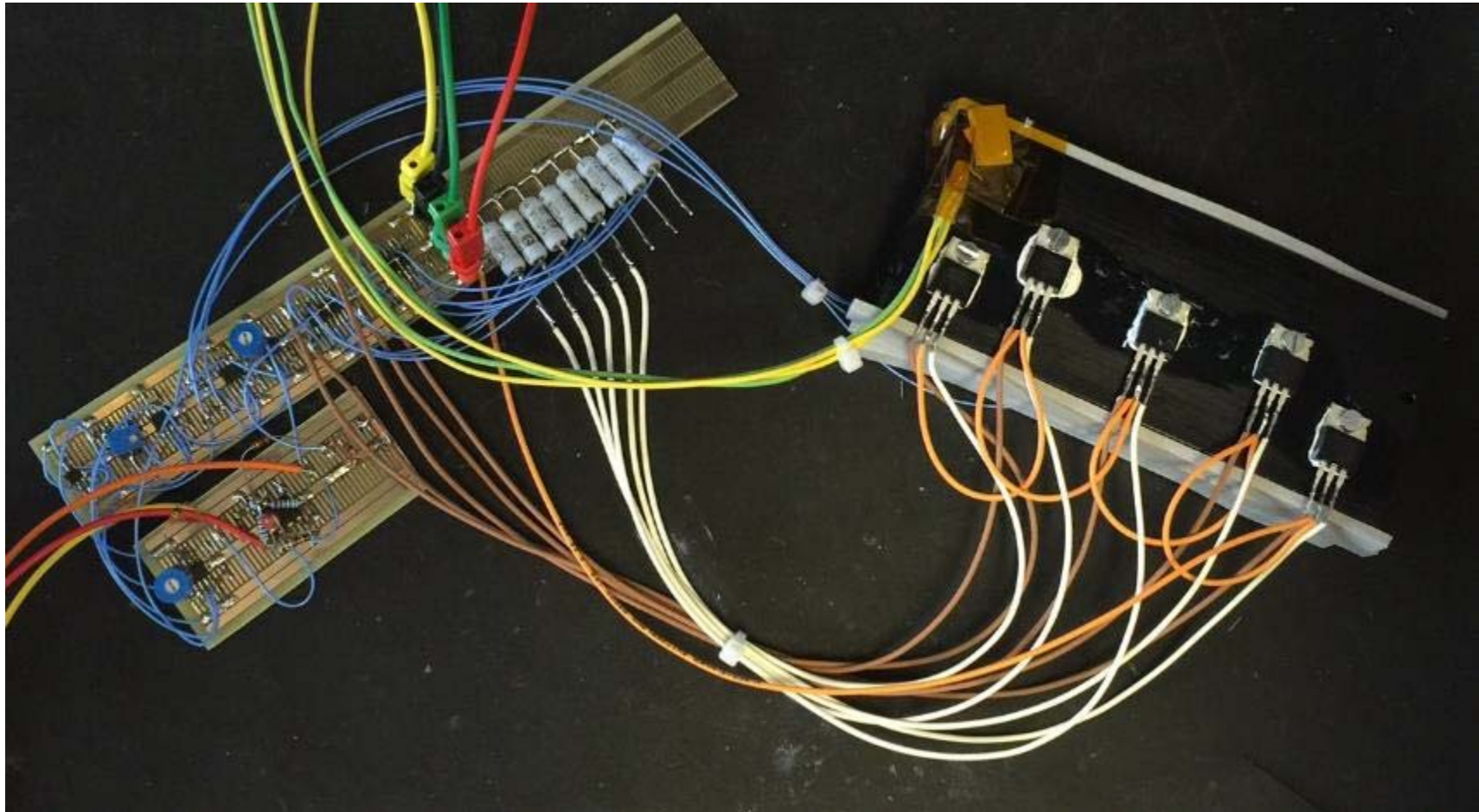

Performance of the controller

- Step response (switch on transient)
- Constant ambient temperature of 22 °C
- Setpoint temperature of 45 °C

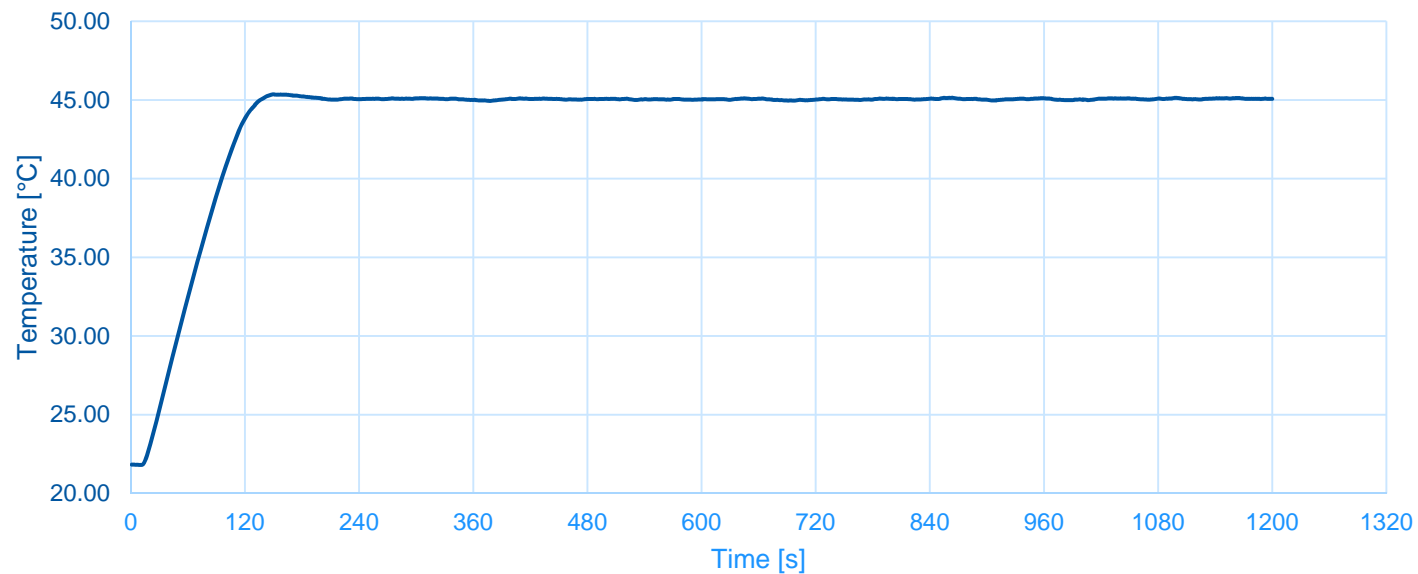

Performance of the controller

- Stability at constant ambient temperature 22 °C

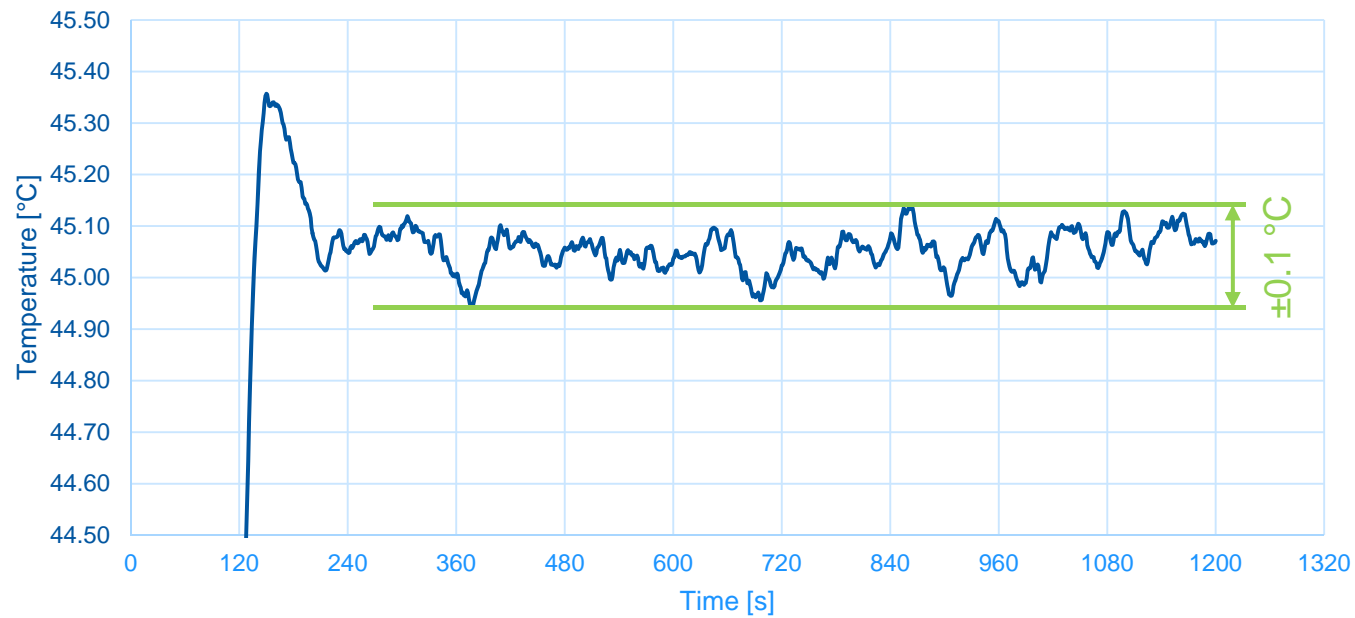

Performance of the controller

- Response to a large external perturbation
- Setpoint temperature 45 °C
- Variation of ambient temperature from 15 to 29 °C when the thermal chamber was heating up



Performance of the controller

- Response to a large external perturbation
- Setpoint temperature of 45 °C
- Variation of ambient temperature from 31 to 17 °C when the thermal chamber was cooling down

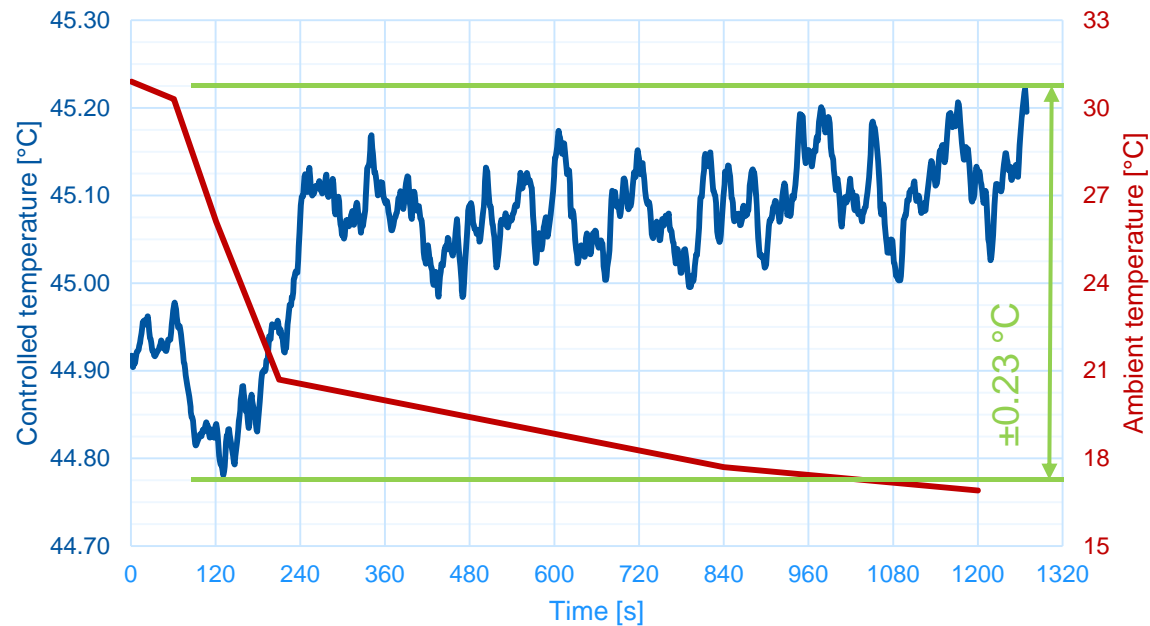

Performance of the controller

- Captured analogue regulator signals during initial heat up from 23 to 45 °C

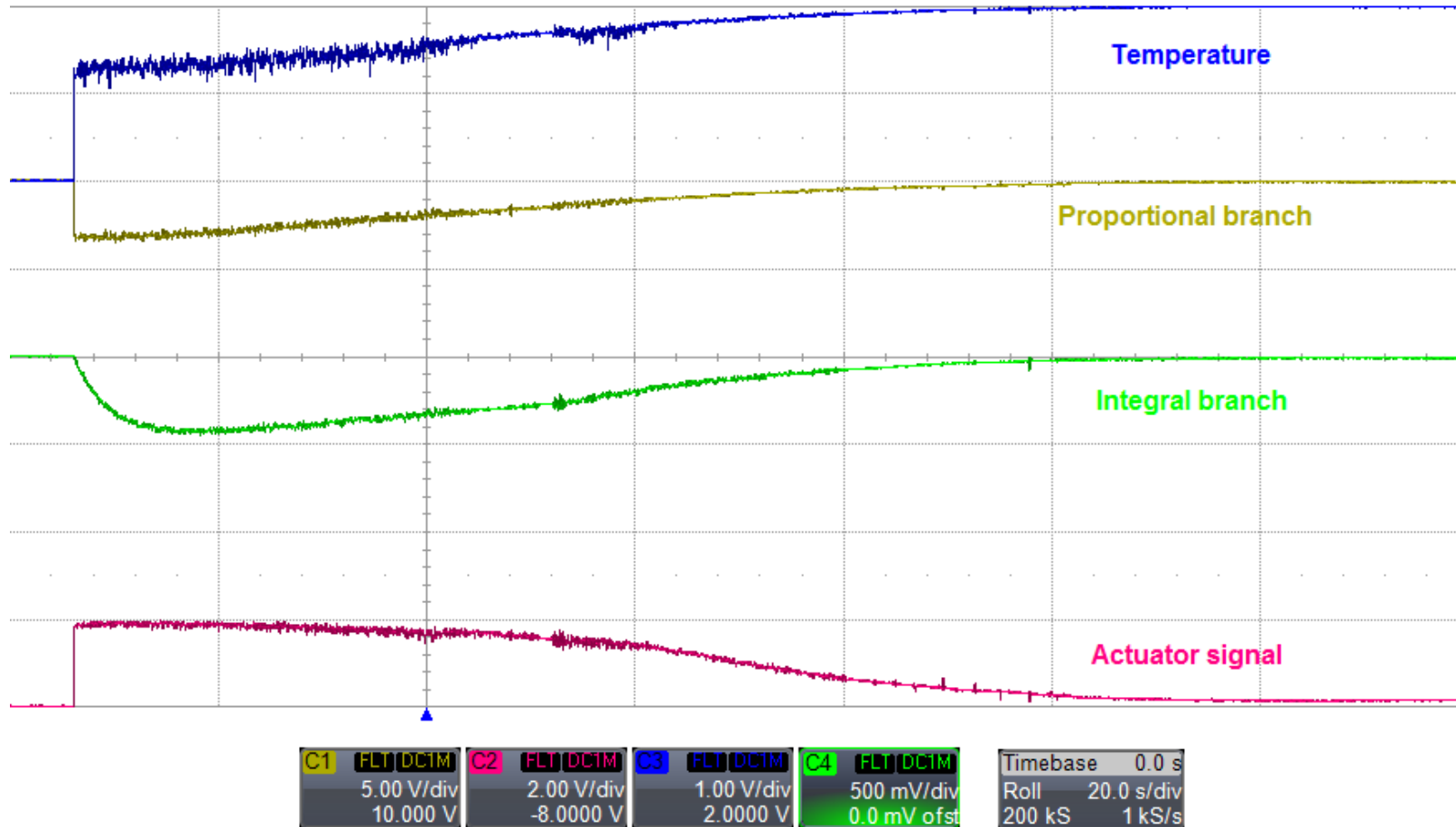

Project status

- Controller prototype successfully tested
- Final PCB designed and production file ready to sent out
- Mechanical design – drawings being finalized by P. Hofer
- Whole unit ready to be sent for production and installation in BA2

Project status

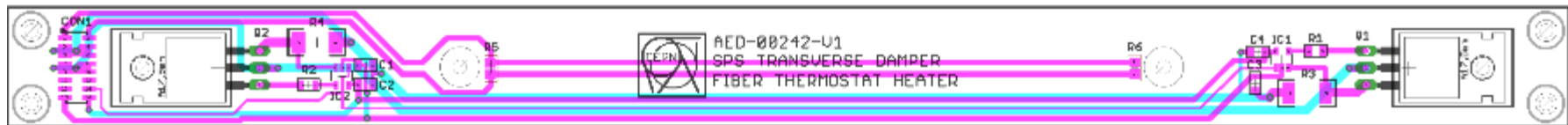
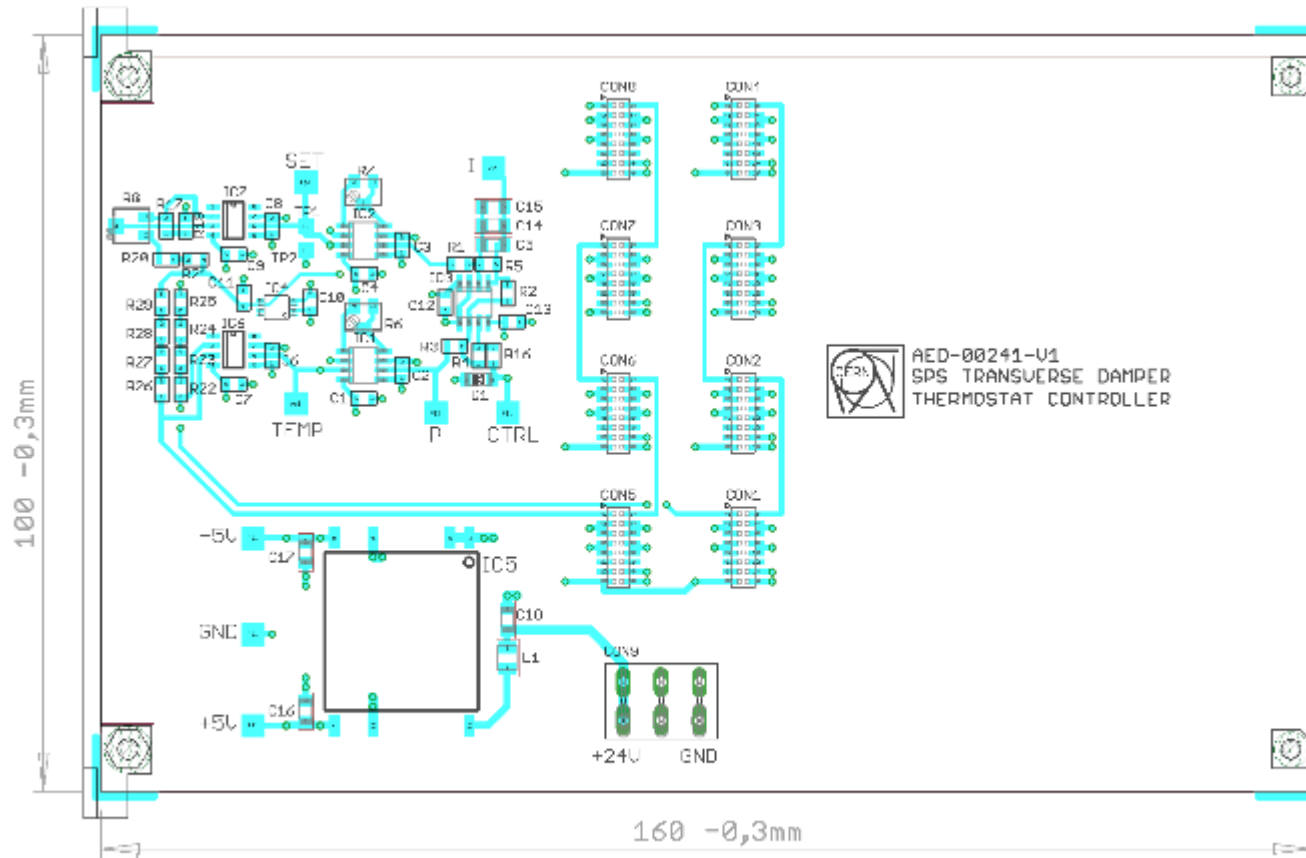

High voltage divider signal conditioner

- Second project I was working on during my stay
- Conditioning of RF-divider signals of the SPS transverse damper tetrode amplifier. Analogue and RF circuitry, 20 MHz bandwidth, fan-out, multiple 50Ω line drivers.
- Prototype assembled, ready for tests

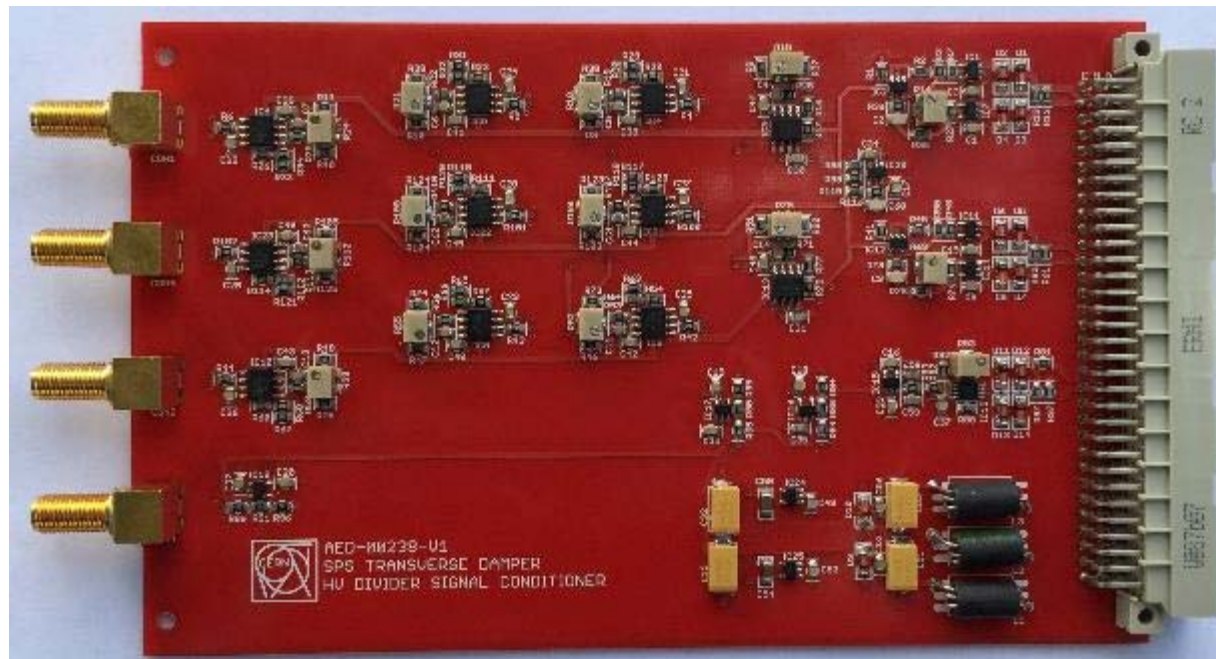

Questions ?

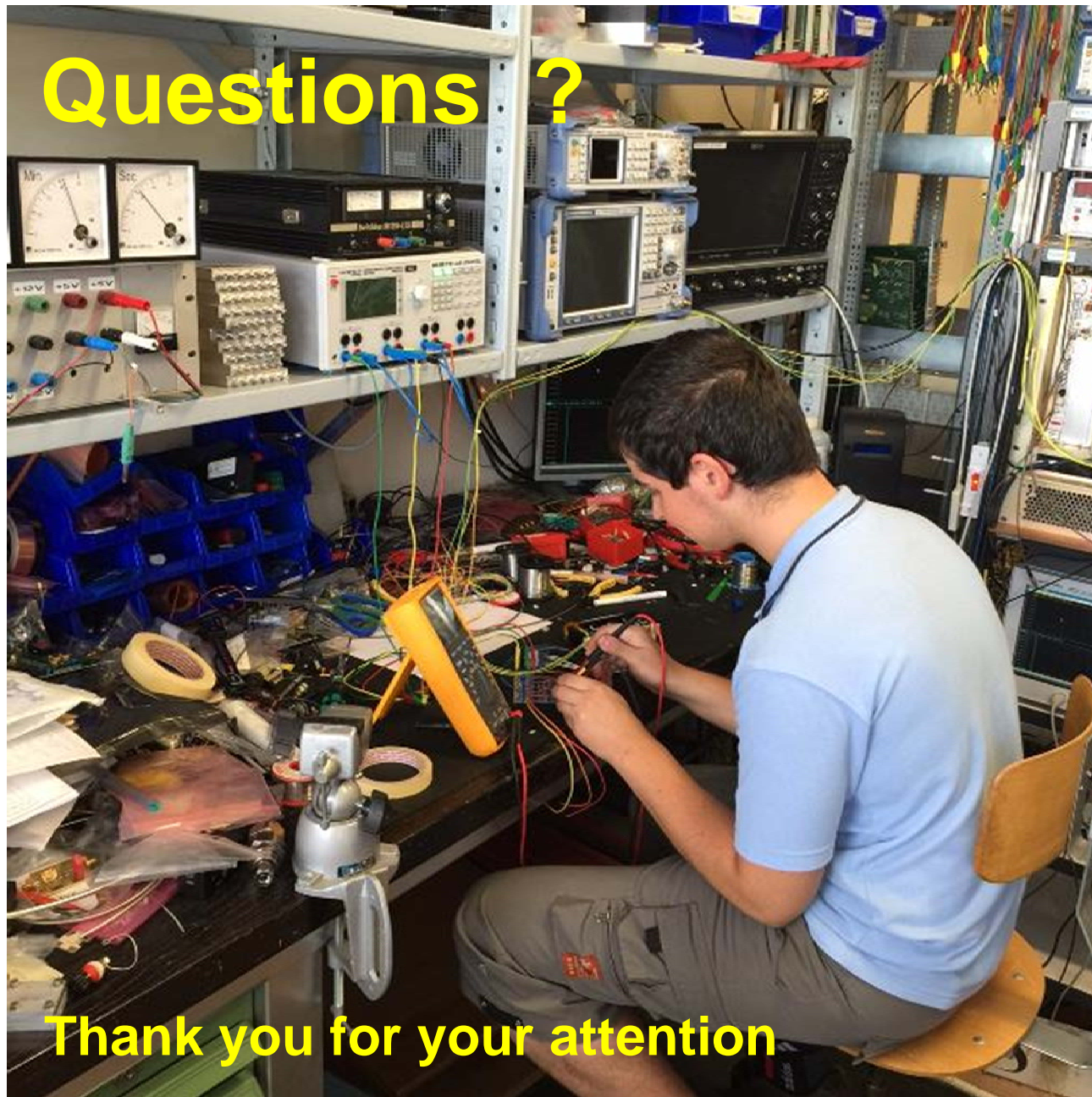

Thank you for your attention

